

Model 2303/2303B/2303-PJ
High Speed Power Supply
Service Manual

Contains Servicing Information

KEITHLEY

WARRANTY

Keithley Instruments, Inc. warrants this product to be free from defects in material and workmanship for a period of 2 years from date of shipment.

Keithley Instruments, Inc. warrants the following items for 90 days from the date of shipment: probes, cables, rechargeable batteries, diskettes, and documentation.

During the warranty period, we will, at our option, either repair or replace any product that proves to be defective.

To exercise this warranty, write or call your local Keithley representative, or contact Keithley headquarters in Cleveland, Ohio. You will be given prompt assistance and return instructions. Send the product, transportation prepaid, to the indicated service facility. Repairs will be made and the product returned, transportation prepaid. Repaired or replaced products are warranted for the balance of the original warranty period, or at least 90 days.

LIMITATION OF WARRANTY

This warranty does not apply to defects resulting from product modification without Keithley's express written consent, or misuse of any product or part. This warranty also does not apply to fuses, software, non-rechargeable batteries, damage from battery leakage, or problems arising from normal wear or failure to follow instructions.

THIS WARRANTY IS IN LIEU OF ALL OTHER WARRANTIES, EXPRESSED OR IMPLIED, INCLUDING ANY IMPLIED WARRANTY OF MERCHANTABILITY OR FITNESS FOR A PARTICULAR USE. THE REMEDIES PROVIDED HEREIN ARE BUYER'S SOLE AND EXCLUSIVE REMEDIES.

NEITHER KEITHLEY INSTRUMENTS, INC. NOR ANY OF ITS EMPLOYEES SHALL BE LIABLE FOR ANY DIRECT, INDIRECT, SPECIAL, INCIDENTAL OR CONSEQUENTIAL DAMAGES ARISING OUT OF THE USE OF ITS INSTRUMENTS AND SOFTWARE EVEN IF KEITHLEY INSTRUMENTS, INC., HAS BEEN ADVISED IN ADVANCE OF THE POSSIBILITY OF SUCH DAMAGES. SUCH EXCLUDED DAMAGES SHALL INCLUDE, BUT ARE NOT LIMITED TO: COSTS OF REMOVAL AND INSTALLATION, LOSSES SUSTAINED AS THE RESULT OF INJURY TO ANY PERSON, OR DAMAGE TO PROPERTY.

KEITHLEY

Keithley Instruments, Inc. • 28775 Aurora Road • Cleveland, OH 44139 • 440-248-0400 • Fax: 440-248-6168 • <http://www.keithley.com>

BELGIUM:	Keithley Instruments B.V.	Bergensesteenweg 709 • B-1600 Sint-Pieters-Leeuw • 02/363 00 40 • Fax: 02/363 00 64
CHINA:	Keithley Instruments China	Yuan Chen Xin Building, Room 705 • 12 Yumin Road, Dewai, Madian • Beijing 100029 • 8610-62022886 • Fax: 8610-62022892
FRANCE:	Keithley Instruments Sarl	3, allée des Garays • 91127 Palaiseau Cedex • 01-64 53 20 20 • Fax: 01-60 11 77 26
GERMANY:	Keithley Instruments GmbH	Landsberger Strasse 65 • 82110 Germering • 089/84 93 07-40 • Fax: 089/84 93 07-34
GREAT BRITAIN:	Keithley Instruments Ltd	Unit 2 Commerce Park, Brunel Road • Theale • Reading • Berkshire RG7 4AB • 0118 929 7500 • Fax: 0118 929 7519
INDIA:	Keithley Instruments GmbH	Flat 2B, WILOCRISSA • 14, Rest House Crescent • Bangalore 560 001 • 91-80-509-1320/21 • Fax: 91-80-509-1322
ITALY:	Keithley Instruments s.r.l.	Viale S. Gimignano, 38 • 20146 Milano • 02-48 39 16 01 • Fax: 02-48 30 22 74
NETHERLANDS:	Keithley Instruments B.V.	Postbus 559 • 4200 AN Gorinchem • 0183-635333 • Fax: 0183-630821
SWITZERLAND:	Keithley Instruments SA	Kriesbachstrasse 4 • 8600 Dübendorf • 01-821 94 44 • Fax: 01-820 30 81
TAIWAN:	Keithley Instruments Taiwan	1 Fl. 85 Po Ai Street • Hsinchu, Taiwan, R.O.C. • 886-3572-9077 • Fax: 886-3572-903

Model 2303/2303B/2303-PJ High Speed Power Supply Service Manual

©1998, Keithley Instruments, Inc.
All rights reserved.
Cleveland, Ohio, U.S.A.
Third Printing, November 1999
Document Number: 2303-902-01 Rev. C

Manual Print History

The print history shown below lists the printing dates of all Revisions and Addenda created for this manual. The Revision Level letter increases alphabetically as the manual undergoes subsequent updates. Addenda, which are released between Revisions, contain important change information that the user should incorporate immediately into the manual. Addenda are numbered sequentially. When a new Revision is created, all Addenda associated with the previous Revision of the manual are incorporated into the new Revision of the manual. Each new Revision includes a revised copy of this print history page.

Revision A (Document Number 2303-902-01)	January 1998
Revision B (Document Number 2303-902-01)	June 1998
Revision C (Document Number 2303-902-01)	November 1999

Safety Precautions

The following safety precautions should be observed before using this product and any associated instrumentation. Although some instruments and accessories would normally be used with non-hazardous voltages, there are situations where hazardous conditions may be present.

This product is intended for use by qualified personnel who recognize shock hazards and are familiar with the safety precautions required to avoid possible injury. Read the operating information carefully before using the product.

The types of product users are:

Responsible body is the individual or group responsible for the use and maintenance of equipment, for ensuring that the equipment is operated within its specifications and operating limits, and for ensuring that operators are adequately trained.

Operators use the product for its intended function. They must be trained in electrical safety procedures and proper use of the instrument. They must be protected from electric shock and contact with hazardous live circuits.

Maintenance personnel perform routine procedures on the product to keep it operating, for example, setting the line voltage or replacing consumable materials. Maintenance procedures are described in the manual. The procedures explicitly state if the operator may perform them. Otherwise, they should be performed only by service personnel.

Service personnel are trained to work on live circuits, and perform safe installations and repairs of products. Only properly trained service personnel may perform installation and service procedures.

Exercise extreme caution when a shock hazard is present. Lethal voltage may be present on cable connector jacks or test fixtures. The American National Standards Institute (ANSI) states that a shock hazard exists when voltage levels greater than 30V RMS, 42.4V peak, or 60VDC are present. **A good safety practice is to expect that hazardous voltage is present in any unknown circuit before measuring.**

Users of this product must be protected from electric shock at all times. The responsible body must ensure that users are prevented access and/or insulated from every connection point. In some cases, connections must be exposed to potential human contact. Product users in these circumstances must be trained to protect themselves from the risk of electric shock. If the circuit is capable of operating at or above 1000 volts, **no conductive part of the circuit may be exposed.**

As described in the International Electrotechnical Commission (IEC) Standard IEC 664, digital multimeter measuring circuits (e.g., Keithley Models 175A, 199, 2000, 2001, 2002, and 2010) are Installation Category II. All other instruments' signal terminals are Installation Category I and must not be connected to mains.

Do not connect switching cards directly to unlimited power circuits. They are intended to be used with impedance limited sources. **NEVER** connect switching cards directly to AC mains. When connecting sources to switching cards, install protective devices to limit fault current and voltage to the card.

Before operating an instrument, make sure the line cord is connected to a properly grounded power receptacle. Inspect the connecting cables, test leads, and jumpers for possible wear, cracks, or breaks before each use.

For maximum safety, do not touch the product, test cables, or any other instruments while power is applied to the circuit under test. **ALWAYS** remove power from the entire test system and discharge any capacitors before: connecting or disconnecting cables or jumpers, installing or removing switching cards, or making internal changes, such as installing or removing jumpers.

Do not touch any object that could provide a current path to the common side of the circuit under test or power line (earth) ground. Always make measurements with dry hands while standing on a dry, insulated surface capable of withstanding the voltage being measured.

The instrument and accessories must be used in accordance with its specifications and operating instructions or the safety of the equipment may be impaired.

Do not exceed the maximum signal levels of the instruments and accessories, as defined in the specifications and operating information, and as shown on the instrument or test fixture panels, or switching card.

When fuses are used in a product, replace with same type and rating for continued protection against fire hazard.

Chassis connections must only be used as shield connections for measuring circuits, NOT as safety earth ground connections.

If you are using a test fixture, keep the lid closed while power is applied to the device under test. Safe operation requires the use of a lid interlock.

If a  screw is present, connect it to safety earth ground using the wire recommended in the user documentation.

The  symbol on an instrument indicates that the user should refer to the operating instructions located in the manual.

The  symbol on an instrument shows that it can source or measure 1000 volts or more, including the combined effect of normal and common mode voltages. Use standard safety precautions to avoid personal contact with these voltages.

The **WARNING** heading in a manual explains dangers that might result in personal injury or death. Always read the associated information very carefully before performing the indicated procedure.

The **CAUTION** heading in a manual explains hazards that could damage the instrument. Such damage may invalidate the warranty.

Instrumentation and accessories shall not be connected to humans.

Before performing any maintenance, disconnect the line cord and all test cables.

To maintain protection from electric shock and fire, replacement components in mains circuits, including the power transformer, test leads, and input jacks, must be purchased from Keithley Instruments. Standard fuses, with applicable national safety approvals, may be used if the rating and type are the same. Other components that are not safety related may be purchased from other suppliers as long as they are equivalent to the original component. (Note that selected parts should be purchased only through Keithley Instruments to maintain accuracy and functionality of the product.) If you are unsure about the applicability of a replacement component, call a Keithley Instruments office for information.

To clean an instrument, use a damp cloth or mild, water based cleaner. Clean the exterior of the instrument only. Do not apply cleaner directly to the instrument or allow liquids to enter or spill on the instrument. Products that consist of a circuit board with no case or chassis (e.g., data acquisition board for installation into a computer) should never require cleaning if handled according to instructions. If the board becomes contaminated and operation is affected, the board should be returned to the factory for proper cleaning/servicing.

Table of Contents

1 Performance Verification

Introduction.....	1-2
Verification test requirements	1-2
Environmental conditions	1-2
Warm-up period	1-2
Line power	1-3
Recommended test equipment	1-3
Resistor connections	1-3
Resistor considerations	1-4
Verification limits.....	1-4
Example limits calculation.....	1-4
Performing the verification test procedures	1-5
Test summary	1-5
Test considerations.....	1-5
Instrument programming	1-5
Output voltage accuracy.....	1-5
Voltage readback accuracy.....	1-7
Compliance current accuracy.....	1-7
Current readback accuracy.....	1-9
5A range readback accuracy	1-9
Models 2303 and 2303B 5mA range readback accuracy.....	1-10
Model 2303-PJ 500mA range readback accuracy	1-11
Digital voltmeter input accuracy.....	1-13

2 Calibration

Introduction.....	2-2
Environmental conditions	2-2
Temperature and relative humidity	2-2
Warm-up period	2-2
Line power	2-2
Calibration considerations	2-2
Calibration cycle	2-3
Recommended calibration equipment.....	2-3
Resistor connections	2-3
Resistor considerations	2-4
Front panel calibration	2-4
Model 2303 front panel calibration.....	2-4
Model 2303-PJ front panel calibration	2-10
Remote calibration	2-14
Remote calibration commands.....	2-14
Remote calibration display	2-15
Models 2303 and 2303B remote calibration procedure.....	2-15
Model 2303-PJ remote calibration procedure.....	2-18
Changing the calibration code	2-21

Changing the code from the front panel	2-21
Changing the code by remote	2-21
Resetting the calibration code	2-22
Viewing calibration date and count	2-22
Viewing date and count from the front panel	2-22
Acquiring date and count by remote	2-22

3 Disassembly

Introduction	3-2
Handling and cleaning	3-2
Handling PC boards	3-2
Solder repairs	3-2
Static sensitive devices	3-2
Assembly drawings	3-3
Disassembly procedures	3-3
Case cover removal	3-3
Analog board removal	3-4
Digital board removal	3-4
Front panel disassembly	3-4
Removing mechanical components	3-5
Instrument re-assembly	3-5

4 Replaceable Parts

Introduction	4-2
Ordering information	4-2
Factory service	4-2
Parts lists and component layouts	4-2
Models 2303 and 2303-PJ parts lists	4-3
Model 2303B parts lists	4-14

A Specifications

Specifications	A-2
Accuracy calculations	A-6
Output and compliance accuracy	A-6
Readback accuracy	A-6
Digital voltmeter input accuracy	A-6

B Calibration Reference

Introduction	B-2
Command summary	B-2
Miscellaneous commands	B-3
Detecting calibration errors	B-6
Reading the error queue	B-6
Error summary	B-6
Status byte EAV (Error Available) bit	B-6

Generating an SRQ on error	B-7
Detecting calibration step completion	B-7
Using the *OPC command.....	B-7
Using the *OPC? query	B-7
Generating an SRQ on calibration complete	B-8

C Calibration Programs

Introduction.....	C-2
Computer hardware requirements.....	C-2
Software requirements	C-2
Calibration equipment.....	C-2
General program instructions.....	C-3
Program C-1 Model 2303/2303B calibration program.....	C-4
Program C-2 Model 2303-PJ calibration program.....	C-6

D Instrument Control

Introduction.....	D-2
Front panel control.....	D-2
Setting the display mode.....	D-2
Selecting the current range.....	D-2
Turning on the output.....	D-2
IEEE-bus control.....	D-3
Setting output values.....	D-3
Setting the reading mode	D-3
Turning on the output.....	D-4
Requesting readings	D-4
Basic control program.....	D-4
Program D-1 Basic control programming.....	D-4

List of Illustrations

1 Performance Verification

Test resistor connections	1-4
Connections for voltage verification tests	1-6
Connections for output current and 5A range current verification tests.....	1-8
Connections for Model 2303 and 2303B	
5mA current verification tests	1-10
Connections for Model 2303-PJ 500mA current verification tests	1-12
Connections for DVM accuracy verification.....	1-13

2 Calibration

Test resistor connections	2-4
Connections for voltage calibration	2-6
Connections for 5A current calibration	2-7
Connections for 5mA range calibration	2-8
Connections for 500mA range calibration	2-12

List of Tables

1 Performance Verification

Recommended verification equipment	1-3
Output voltage accuracy limits	1-6
Voltage readback accuracy limits.....	1-7
Compliance current accuracy limits.....	1-9
5A range current readback accuracy limits.....	1-10
Model 2303 and 2303B 5mA range current readback accuracy limits. 1-11	
Model 2303-PJ 500mA range current readback accuracy limits	1-13
Digital voltmeter input accuracy limits.....	1-14

2 Calibration

Recommended calibration equipment.....	2-3
Front panel calibration summary	2-9
Model 2303-PJ front panel calibration summary.....	2-13
Remote calibration command summary	2-14
Models 2303 and 2303B remote calibration summary	2-17
Model 2303-PJ remote calibration summary	2-20

4 Replaceable parts

Models 2303 and 2303-PJ digital board parts list.....	4-3
Models 2303 and 2303-PJ analog board parts list	4-8
Models 2303 and 2303-PJ display board parts	4-12
Models 2303 and 2303-PJ mechanical parts list.....	4-13
Model 2303B digital board parts list	4-14
Model 2303B analog board parts list.....	4-19
Model 2303B mechanical parts list.....	4-23

B Calibration Reference

Remote calibration command summary	B-2
Calibration step summary	B-5
Calibration errors	B-6

D Instrument Control

Basic remote commands	D-3
-----------------------------	-----



1 Performance Verification

Introduction

Use the procedures in this section to verify that Model 2303, Model 2303B, or Model 2303-PJ accuracy is within the limits stated in the accuracy specifications. You can perform these verification procedures:

- When you first receive the unit to make sure that it was not damaged during shipment.
- To verify that the unit meets factory specifications.
- To determine if calibration is required.
- Following calibration to make sure it was performed properly.

WARNING The information in this section is intended only for qualified service personnel. Do not attempt these procedures unless you are qualified to do so.

NOTE *If the power supply is still under warranty, and its performance is outside specified limits, contact your Keithley representative or the factory to determine the correct course of action.*

Verification test requirements

Be sure that you perform the verification tests:

- Under the proper environmental conditions.
- After the specified warm-up period.
- Using the correct line voltage.
- Using the proper test equipment.
- Using the specified output signals and reading limits.

Environmental conditions

Conduct your performance verification procedures in a test environment with:

- An ambient temperature of 18-28°C (65-82°F).
- A relative humidity of less than 70% unless otherwise noted.

Warm-up period

Allow the Model 2303 to warm up for at least one hour before conducting the verification procedures.

If the unit has been subjected to temperature extremes (those outside the ranges stated above), allow additional time for the instrument's internal temperature to stabilize. Typically, allow one extra hour to stabilize a unit that is 10°C (18°F) outside the specified temperature range.

Also, allow the test equipment to warm up for the minimum time specified by the manufacturer.

Line power

The Model 2303 requires a line voltage of 100 to 240V and a line frequency of 50 to 60Hz. Verification tests must be performed within this range.

Recommended test equipment

Table 1-1 summarizes recommended verification equipment. You can use alternate equipment as long as that equipment has specifications at least four times better than corresponding Model 2303, 2303B, or 2303-PJ specifications. Keep in mind, however, that test equipment accuracy will add to the uncertainty of each measurement.

Table 1-1
Recommended verification equipment

Description	Manufacturer/Model	Specifications
Digital Multimeter	Keithley 2001	DC Voltage ¹ 20V: ± 22 ppm Resistance ¹ 20 Ω : ± 59 ppm 200 Ω : ± 43 ppm 20k Ω : ± 36 ppm
Precision Resistor		1 Ω , 0.1%, 100W ²
Precision Resistor		30 Ω , 0.1%, 50W ³
Precision Resistor		3k Ω , 0.1%, 0.25W ⁴

1. Full-range, 90-day, 23°C various measurement points.
2. Characterize resistor using 4-wire ohms function and 20 Ω range of DMM before use.
3. Used only for Model 2303-PJ. Characterize resistor using 4-wire ohms function and 200 Ω range of DMM before use. See Resistor considerations for temperature coefficient.
4. Used only for Models 2303 and 2303B. Characterize resistor using 4-wire ohms function and 20k Ω range of DMM before use.

Resistor connections

When performing the verification tests, make connections to the test resistors as shown in Figure 1-1. Be sure to connect the Model 2303 SENSE leads and DMM test leads as close to the resistor body as possible.

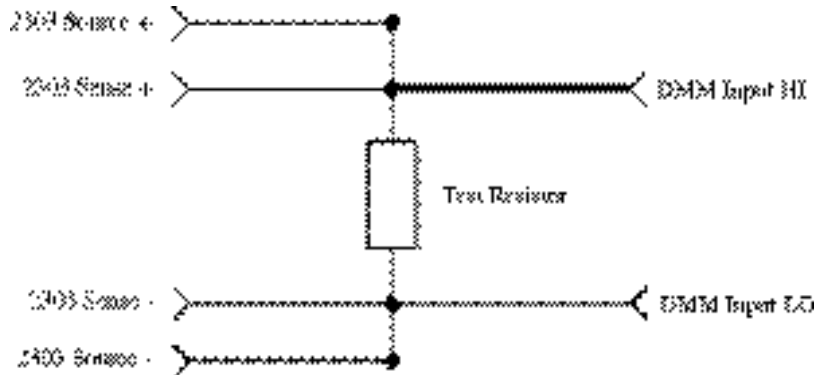

Figure 1-1
Test resistor connections

Resistor considerations

The test resistors should be characterized using the lowest possible range and the 4-wire ohms function of the DMM recommended in Table 1-1 to measure the resistance values. Use the measured resistance values to calculate the actual currents during the test procedures.

NOTE The temperature coefficient and temperature change of the 1Ω and 30Ω resistors when passing current at full load must be low enough so that the change in resistance does not cause incorrect readings as follows:

$V_{OUT}/\Delta R < 25\%$ of Model 2303 amps specification. (V_{OUT} is the Model 2303 output voltage, and ΔR is the change in resistance caused by heating.)

Verification limits

The verification limits stated in this section have been calculated using only the Model 2303 accuracy specifications, and *they do not include test equipment uncertainty*. If a particular measurement falls outside the allowable range, recalculate new limits based both on Model 2303 specifications and corresponding test equipment specifications.

Example limits calculation

As an example of how verification limits are calculated, assume you are testing the power supply using a 10V output value. Using the Model 2303 voltage output accuracy specification of $\pm(0.05\%$ of output + 10mV offset), the calculated output limits are:

$$\text{Output limits} = 10\text{V} \pm [(10\text{V} \times 0.05\%) + 10\text{mV}]$$

$$\text{Output limits} = 10\text{V} \pm (0.005 + 0.01)$$

$$\text{Output limits} = 10\text{V} \pm 0.015\text{V}$$

$$\text{Output limits} = 9.985\text{V to } 10.015\text{V}$$

Performing the verification test procedures

Test summary

- DC voltage output accuracy
- DC voltage readback accuracy
- DC current output accuracy
- DC current readback accuracy
- Digital voltmeter input accuracy

If the Model 2303 is not within specifications and not under warranty, see the calibration procedures in Section 2 for information on calibrating the unit.

Test considerations

When performing the verification procedures:

- Make sure that the test equipment is properly warmed up and connected to the correct Model 2303 terminals on the rear panel. Also be sure the test equipment is set up for the proper function and range.
- Do not connect test equipment to the Model 2303 through a scanner, multiplexer, or other switching equipment.
- Be sure that the power supply output is turned on before making measurements.
- Allow the power supply output signal to settle before making a measurement.

Instrument programming

Refer to *Appendix D* for basic information on programming the Model 2303, 2303B, or 2303-PJ from the front panel or over the bus.

Output voltage accuracy

Follow the steps below to verify that Model 2303, 2303B, or 2303-PJ output voltage accuracy is within specified limits. This test involves setting the output voltage to specific values and measuring the voltages with a precision digital multimeter.

1. With the power off, connect the digital multimeter to the Model 2303 OUTPUT SOURCE terminals, as shown in Figure 1-2. Be sure to observe proper polarity (SOURCE + to INPUT HI; SOURCE - to INPUT LO).

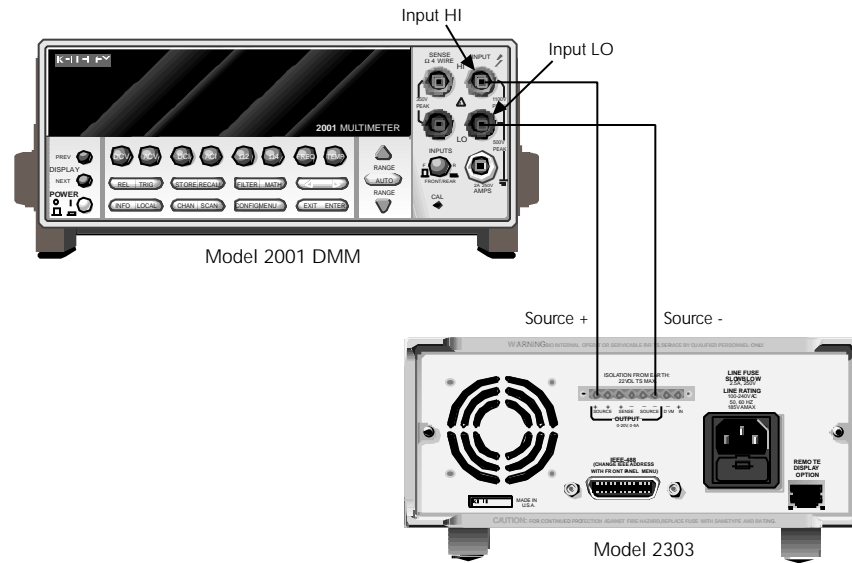

Figure 1-2
Connections for voltage verification tests

2. Select the multimeter DC volts measuring function, and enable auto-ranging.
3. Make sure the Model 2303 output is turned on.
4. Verify output voltage accuracy for each of the voltages listed in Table 1-2. For each test point:
 - Set the Model 2303 output voltage to the indicated value. When setting the voltage, set the compliance current to 3A.
 - Allow the reading to settle.
 - Verify that the multimeter reading is within the limits given in the table.

Table 1-2
Output voltage accuracy limits

Model 2303 output voltage setting	Output voltage limits (1 Year, 18°C-28°C)
5.00V	4.9875 to 5.0125V
10.00V	9.985 to 10.015V
15.00V	14.9825 to 15.0175V

Voltage readback accuracy

Follow the steps below to verify that Model 2303, 2303B, or 2303-PJ voltage readback accuracy is within specified limits. The test involves setting the source voltage to specific values, as measured by a digital multimeter, and then verifying that voltage readback readings are within required limits.

1. With the power off, connect the digital multimeter to the Model 2303 OUTPUT SOURCE terminals, as shown in Figure 1-3. Be sure to observe proper polarity (SOURCE + to INPUT HI; SOURCE - to INPUT LO).
2. Select the multimeter DC volts function, and enable auto-ranging.
3. Make sure actual voltage readings are being displayed (use DISPLAY), and turn on the Model 2303 output.
4. Verify voltage readback accuracy for each of the voltages listed in Table 1-3. For each test point:
 - Set the Model 2303 output voltage to the indicated value *as measured by the digital multimeter*. Note that it may not be possible to set the voltage source precisely to the specified value. Use the closest possible setting, and modify reading limits accordingly. When setting the voltage, set the compliance current to 3A.
 - Allow the reading to settle.
 - Verify that the actual Model 2303 voltage reading is within the limits given in the table.

Table 1-3
Voltage readback accuracy limits

Model 2303 output voltage setting*	Voltage readback limits (1 Year, 18°C-28°C)
5.00V	4.995 to 5.005V
10.00V	9.992 to 10.008V
14.00V	13.990 to 14.010V

* As measured by digital multimeter. See procedure.

Compliance current accuracy

Follow the steps below to verify that Model 2303, 2303B, or 2303-PJ compliance current accuracy is within specified limits. The test involves setting the compliance current to specific values and determining the actual current by measuring the voltages across a characterized 1Ω resistor with a precision digital multimeter.

1. With the power off, connect the digital multimeter and characterized 1Ω resistor to the Model 2303 OUTPUT SOURCE terminals, as shown in Figure 1-3. Be sure to observe

proper polarity (SOURCE + to INPUT HI; SOURCE - to INPUT LO). Also be sure to use 4-wire connections to the resistor terminals.

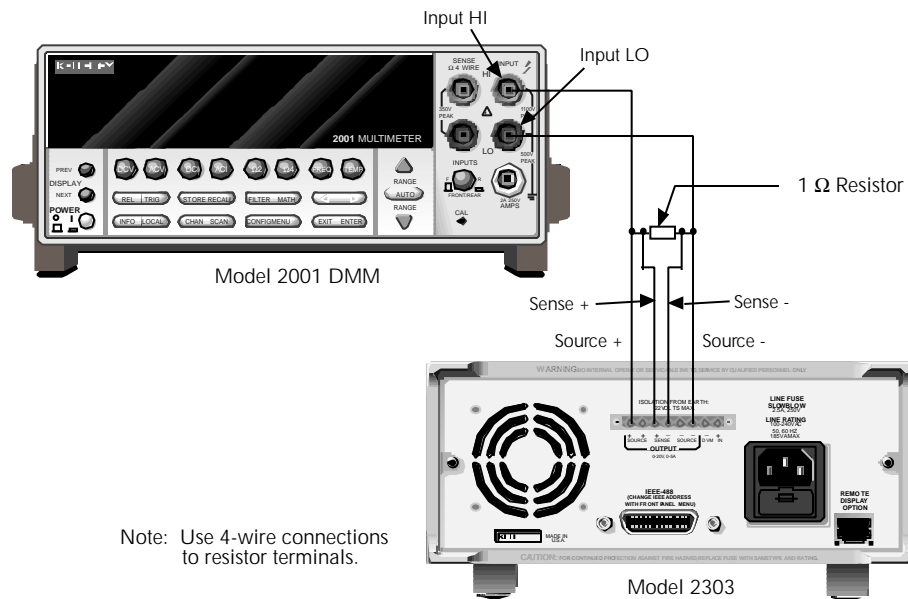

Figure 1-3
Connections for output current and 5A range current verification tests

2. Select the multimeter DC voltage measuring function, and enable auto-ranging.
3. Turn on the Model 2303 output.
4. Verify compliance current accuracy for the currents listed in Table 1-4. For each test point:
 - Set the Model 2303 output voltage to 9V, and set the compliance current to the value being tested.
 - Note and record the digital multimeter voltage reading.
 - Calculate the current from the voltage reading and actual 1Ω resistor value: $I = V/R$
 - Verify that the current is within the limits given in the table.

Table 1-4
Compliance current accuracy limits

Model 2303 compliance current setting	Compliance current limits (1 Year, 18°C-28°C)
1.000A	0.993 to 1.007A
2.000A	1.992 to 2.008A
3.000A	2.990 to 3.010A
4.000A	3.989 to 4.011A
5.000A	4.987 to 5.013A

Current readback accuracy

Follow the steps below to verify that Model 2303, 2303B, or 2303-PJ current readback accuracy is within specified limits. The test involves setting the output current to specific values as measured with a resistor and precision digital multimeter.

5A range readback accuracy

1. With the power off, connect the digital multimeter and characterized 1Ω resistor to the Model 2303 OUTPUT SOURCE terminals, as shown in Figure 1-3. Be sure to observe proper polarity (SOURCE + to INPUT HI; SOURCE - to INPUT LO). Also be sure to use 4-wire connections to the resistor terminals.
2. Select the multimeter DC volts measuring function, and enable auto-ranging.
3. Select the 5A readback range. Also make sure actual current readings are displayed.
4. Turn on the Model 2303 output.
5. Verify 5A range current readback accuracy for the currents listed in Table 1-5. For each test point:
 - By changing the output voltage, adjust the current to the correct value, *as determined from the multimeter voltage reading and characterized resistance value*. When setting the voltage, be sure to set the compliance current to 5A.
 - Note that it may not be possible to set the output current to the exact value. In that case, set the current to the closest possible value, and modify reading limits accordingly.
 - Allow the reading to settle.
 - Verify that the actual Model 2303 current reading is within the limits given in the table.

Table 1-5
5A range current readback accuracy limits

Nominal output Voltage	Model 2303 Output current*	Current readback limits (1 Year, 18°C-28°C)
1V	1.000A	0.9976 to 1.0024A
2V	2.000A	1.9956 to 2.0044A
3V	3.000A	2.9936 to 3.0064A
4V	4.000A	3.9916 to 4.0084A
4.9V	4.900A	4.8898 to 4.9102A

* As determined from digital multimeter and 1Ω resistor. See procedure.

Models 2303 and 2303B 5mA range readback accuracy

The following test applies only to the Models 2303 and 2303B:

1. With the power off, connect the digital multimeter and characterized 3kΩ resistor to the Model 2303 or 2303B OUTPUT SOURCE terminals, as shown in Figure 1-4. Be sure to observe proper polarity and connections (3kΩ resistor between SOURCE + and DMM INPUT HI; SOURCE - to DMM INPUT LO).

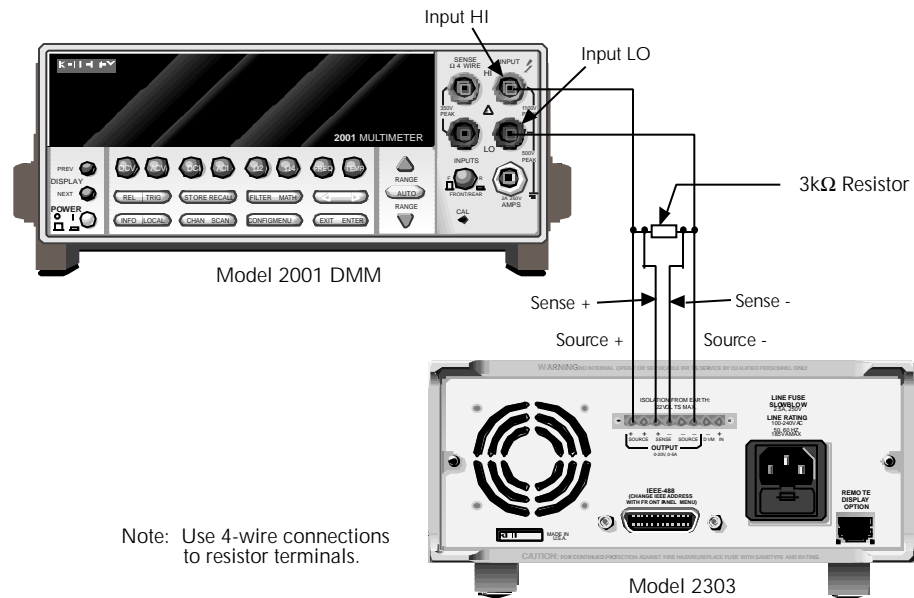

Note: Use 4-wire connections to resistor terminals.

Figure 1-4
Connections for Model 2303 and 2303B 5mA current verification tests

2. Select the multimeter DC volts measuring function, and enable auto-range.
3. Select the 5mA readback range and actual current reading data.
4. Turn on the Model 2303 output.
5. Verify 5mA range current readback accuracy for the currents listed in Table 1-6. For each test point:
 - Set the Model 2303 output current to the correct value, *as determined from the digital multimeter voltage reading and 3k Ω resistance value*. Note that it may not be possible to set the output current to the exact value. In that case, set the current to the closest possible value, and modify reading limits accordingly.
 - Allow the reading to settle.
 - Verify that the actual Model 2303 current reading is within the limits given in the table.

Table 1-6
Model 2303 and 2303B 5mA range current readback accuracy limits

Nominal output Voltage	Model 2303 output current*	Current readback limits (1 Year, 18°C-28°C)
3V	1.0000mA	0.9970 to 1.0030mA
6V	2.0000mA	1.9950 to 2.0050mA
9V	3.0000mA	2.9930 to 3.0070mA
12V	4.0000mA	3.9910 to 4.0090mA
14.7V	4.9000mA	4.8892 to 4.9108mA

* As determined from digital multimeter voltage reading and 3k Ω resistance value. See procedure.

Model 2303-PJ 500mA range readback accuracy

The following tests apply only to the Model 2303-PJ:

1. With the power off, connect the digital multimeter and characterized 30 Ω resistor to the Model 2303-PJ OUTPUT SOURCE terminals, as shown in Figure 1-5. Be sure to observe proper polarity and connections (30 Ω resistor between SOURCE + and DMM INPUT HI; SOURCE - to DMM INPUT LO).

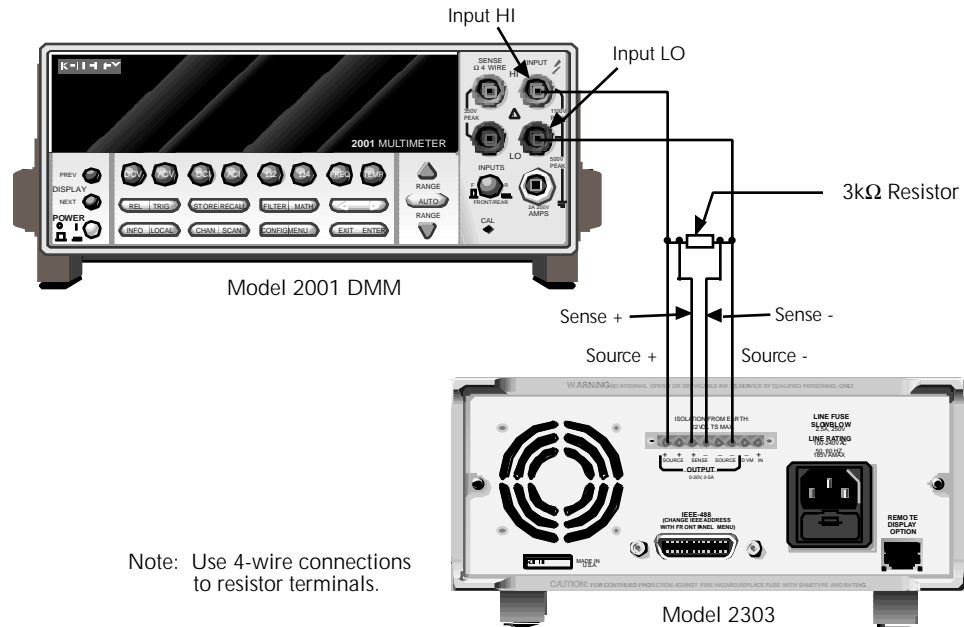

Note: Use 4-wire connections to resistor terminals.

Figure 1-5
Connections for Model 2303-PJ 500mA current verification tests

2. Select the multimeter DC volts measuring function, and enable auto-range.
3. Select the 500mA readback range and actual current reading data.
4. Turn on the Model 2303-PJ output.
5. Verify 500mA range current readback accuracy for the currents listed in Table 1-7. For each test point:
 - Set the Model 2303-PJ output current to the correct value, *as determined from the digital multimeter voltage reading and 30Ω resistance value*. Note that it may not be possible to set the output current to the exact value. In that case, set the current to the closest possible value, and modify reading limits accordingly.
 - Allow the reading to settle.
 - Verify that the actual Model 2303-PJ current reading is within the limits given in the table.

Table 1-7
Model 2303-PJ 500mA range current readback accuracy limits

Nominal output voltage	Model 2303-PJ output current*	Current readback limits (1 Year, 18°C-28°C)
3V	100.00mA	99.76 to 100.24mA
6V	200.00mA	199.56 to 200.44mA
9V	300.00mA	299.36 to 300.64mA
12V	400.00mA	399.16 to 400.84mA
14.7V	490.00mA	488.98 to 491.02mA

Digital voltmeter input accuracy

Follow the steps below to verify that Model 2303, 2303B, and 2303-PJ digital voltmeter input accuracy is within specified limits. The test involves setting the voltage applied to the DVM input to accurate values and then verifying that the Model 2303 digital voltmeter input readings are within required limits.

1. With the power off, connect the Model 2303 DVM IN terminals to OUTPUT SOURCE terminals and the digital multimeter, as shown in Figure 1-6. Be sure to observe proper polarity (DVM IN + to SOURCE + and DMM INPUT HI; DVM IN - to SOURCE - and DMM INPUT LO).

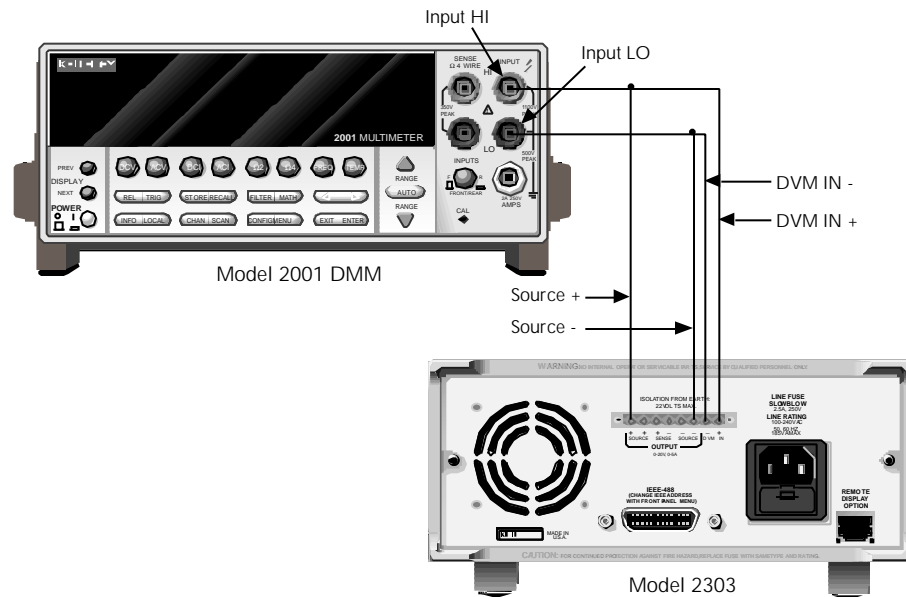

Figure 1-6
Connections for DVM accuracy verification

2. Select the DMM DC volts function, and enable auto-ranging.
3. Enable the Model 2303 DVM input.
4. Turn on the Model 2303 source output.
5. Verify digital voltmeter input accuracy for each of the voltages listed in Table 1-8. For each test point:
 - Set the voltage to the indicated value as measured by the digital multimeter.
 - Set compliance to 3A.
 - Allow the reading to settle.
 - Verify that the Model 2303 voltage reading is within the limits given in the table.

Table 1-8
Digital voltmeter input accuracy limits

Model 2303 output voltage setting*	Digital voltmeter input reading limits (1 Year, 18°C-28°C)
14.00V	13.990 to 14.010V
3.00V	2.996V to 3.004V

* As measured by digital multimeter. See procedure.

2 Calibration

Introduction

Use the procedures in this section to calibrate the Model 2303, 2303B, or 2303-PJ. These procedures require accurate test equipment to measure precise DC voltages and currents. Calibration can be performed either from the front panel (Models 2303 and 2303-PJ only), or by sending SCPI calibration commands over the IEEE-488 bus with the aid of a computer (Models 2303, 2303B, and 2303-PJ).

WARNING The information in this section is intended only for qualified service personnel. Do not attempt these procedures unless you are qualified to do so.

Environmental conditions

Temperature and relative humidity

Conduct the calibration procedures at an ambient temperature of 18-28°C (65-82°F) with a relative humidity of less than 70% unless otherwise noted.

Warm-up period

Allow the Model 2303 to warm up for at least one hour before performing calibration.

If the instrument has been subjected to temperature extremes (those outside the ranges stated above), allow additional time for the instrument's internal temperature to stabilize. Typically, allow one extra hour to stabilize a unit that is 10°C (18°F) outside the specified temperature range.

Also, allow the test equipment to warm up for the minimum time specified by the manufacturer.

Line power

The Model 2303 requires a line voltage of 100 to 240V at line frequency of 50 to 60Hz. The instrument must be calibrated while operating from a line voltage within this range.

Calibration considerations

When performing the calibration procedures:

- Make sure that the test equipment is properly warmed up and connected to the appropriate Model 2303 terminals.
- Always allow the source signal to settle before calibrating each point.
- Do not connect test equipment to the Model 2303 through a scanner or other switching equipment.

- Calibration must be performed in the sequence outlined in this manual, or an error will occur.
- If an error occurs during calibration, the Model 2303 will generate an appropriate error message. See Appendix B for more information.

WARNING The maximum common-mode voltage (voltage between LO and chassis ground) is 22VDC. Exceeding this value may cause a breakdown in insulation, creating a shock hazard.

Calibration cycle

Perform calibration at least once a year to ensure the unit meets or exceeds its specifications.

Recommended calibration equipment

Table 2-1 lists the recommended equipment for the calibration procedures. You can use alternate equipment as long as that equipment has specifications at least four times better than corresponding Model 2303 specifications. See also Resistor considerations for important temperature coefficient information.

Table 2-1
Recommended calibration equipment

Description	Manufacturer/Model	Specifications
Digital Multimeter	Keithley 2001	DC Voltage ¹ 20V: ±22ppm Resistance ¹ 20Ω: ±59ppm 200Ω: ±43ppm 20kΩ: ±36ppm
Precision Resistor		4Ω, 0.1%, 100W ²
Precision Resistor		30Ω, 0.1%, 50W ³
Precision Resistor		3kΩ, 0.1%, 0.125W ⁴

1. Full-range, 90-day, 23°C ±5°C accuracy specifications of ranges required for various measurement points.
2. Characterize resistor using 4-wire ohms function and 20Ω range of DMM before use.
3. Required only for Model 2303-PJ. Characterize resistor using 4-wire ohms function and 200Ω range of DMM before use. See Resistor considerations for temperature coefficient.
4. Required only for Models 2303 and 2303B. Characterize resistor using 4-wire ohms function and 20kΩ range of DMM before use. See Resistor considerations for temperature coefficient.

Resistor connections

When performing calibration, make connections to the test resistors as shown in Figure 2-1. Be sure to connect the Model 2303 SENSE leads and DMM test leads as close to the resistor body as possible.

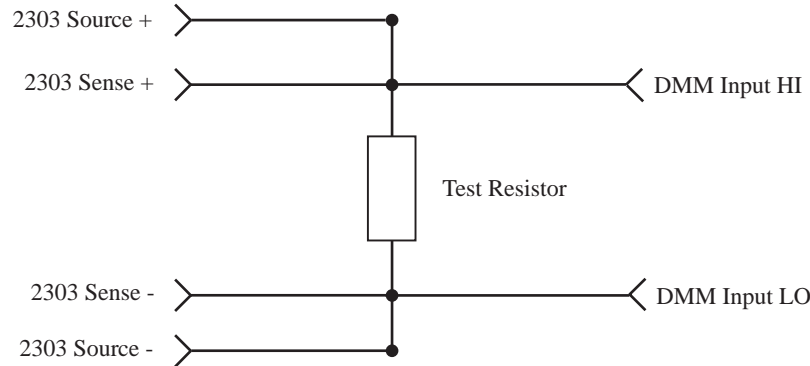

Figure 2-1
Test resistor connections

Resistor considerations

The test resistors should be characterized using the 4-wire ohms function of the DMM recommended in Table 2-1 to measure the resistance values. Use the measured resistance values to calculate the actual currents during the calibration procedures.

NOTE The temperature coefficient and temperature change of the 4Ω and 30Ω resistors when passing current at full load must be low enough so that the change in resistance does not cause incorrect readings as follows:

$V_{OUT}/\Delta R < 25\%$ of Model 2303 amps specification. (V_{OUT} is the Model 2303 output voltage, and ΔR is the change in resistance caused by heating.)

Front panel calibration

Model 2303 and Model 2303-PJ front panel calibration are covered separately below.

Model 2303 front panel calibration

Use the following procedure to calibrate the Model 2303 from the front panel. Table 2-2 summarizes calibration steps.

NOTE Calibration must be performed in the following sequence, or an error will occur. To abort calibration and revert to previous calibration constants at any time during the procedure, press the MENU key.

Step 1: Prepare the Model 2303 for calibration

1. Turn on the Model 2303 and the digital multimeter, and allow them to warm up for at least one hour before performing calibration.
2. Press the MENU key, then choose CALIBRATE UNIT, and press ENTER. The instrument will display the date last calibrated:

```
CALIBRATE UNIT  
LAST ON 02/01/98
```

3. Press the up arrow key. The instrument will display the number of times it was calibrated:

```
CALIBRATE UNIT  
TIMES= 01
```

4. Press the up arrow key. The unit will then prompt you to run calibration:

```
CALIBRATE UNIT  
RUN
```

5. Press ENTER. The unit will then prompt for the calibration code:

```
CALIBRATE UNIT  
Cal Code KI002303
```

6. Using the edit keys, set the display to the current calibration code, then press ENTER. (Default: KI002303.) The unit will then prompt you as to whether or not to change the code:

```
CALIBRATE UNIT  
Change Code NO
```

7. Be sure NO is selected (use the up and down arrow keys), press ENTER, then follow the steps below to calibrate the unit. (See Changing the calibration code at the end of this section if you wish to change the code.)

Step 2: Perform calibration steps

NOTE *The unit will display the most recently calibrated values. Factory defaults are shown in this manual.*

1. Connect both the OUTPUT SOURCE and DVM IN terminals to the digital multimeter, as shown in Figure 2-2. (Connect SOURCE + and DVM IN + to DMM INPUT HI; connect SOURCE - and DVM IN - to DMM INPUT LO.)

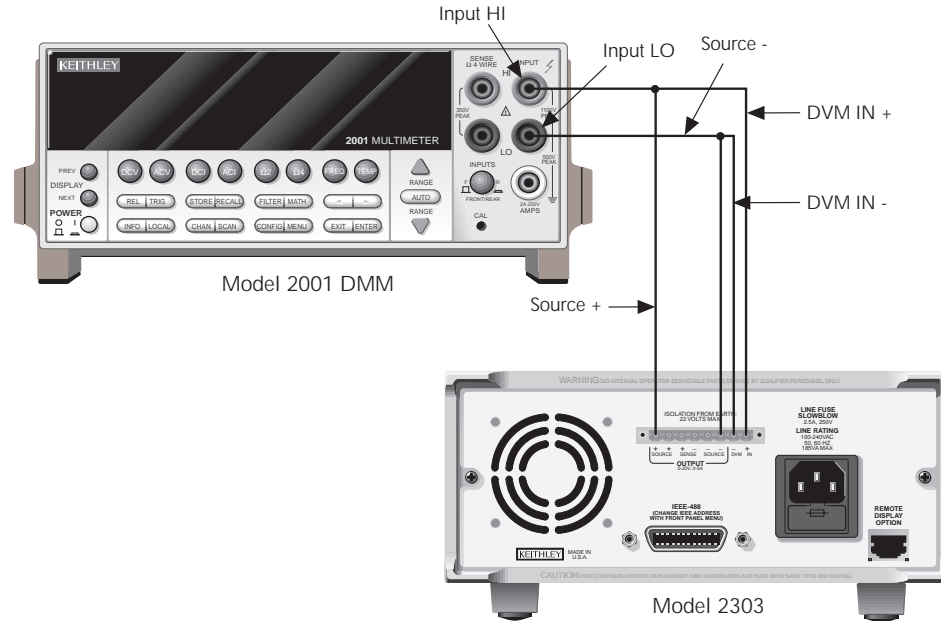

Figure 2-2
Connections for voltage calibration

2. At this point, the Model 2303 will prompt you to set the full-scale output voltage:
FULL SCALE VOLTS
SET 14.0000 V
3. Use the edit keys to set the voltage to 14.0000V, then press ENTER.

NOTE At this point, the source output is turned on and will remain on until calibration is complete or aborted with the MENU key.

4. The unit will prompt you for the DMM reading, which will be used to calibrate the full-scale output voltage:
FULL SCALE VOLTS
READ1 14.0000 V
5. Using the edit keys, adjust the Model 2303 voltage display to agree with the DMM voltage reading, then press ENTER. The unit will then prompt for another DMM reading, which will be used to calibrate the full-scale measurement function:
FULL SCALE VOLTS
READ2 14.0000 V

6. Using the edit keys, adjust the display to agree with the new DMM voltage reading, then press ENTER. The unit will then prompt for DVM full-scale calibration:
FULL SCALE DVM
ALL READY TO DO?
7. Press ENTER to complete DVM full-scale calibration.
8. Connect the digital multimeter volts input and characterized 4Ω resistor to the Model 2303 OUTPUT SOURCE terminals, as shown in Figure 2-3. Be sure to observe proper polarity (SOURCE + to DMM INPUT HI; SOURCE - to INPUT LO).
9. Be sure the digital multimeter DC volts function and auto-ranging are still selected.

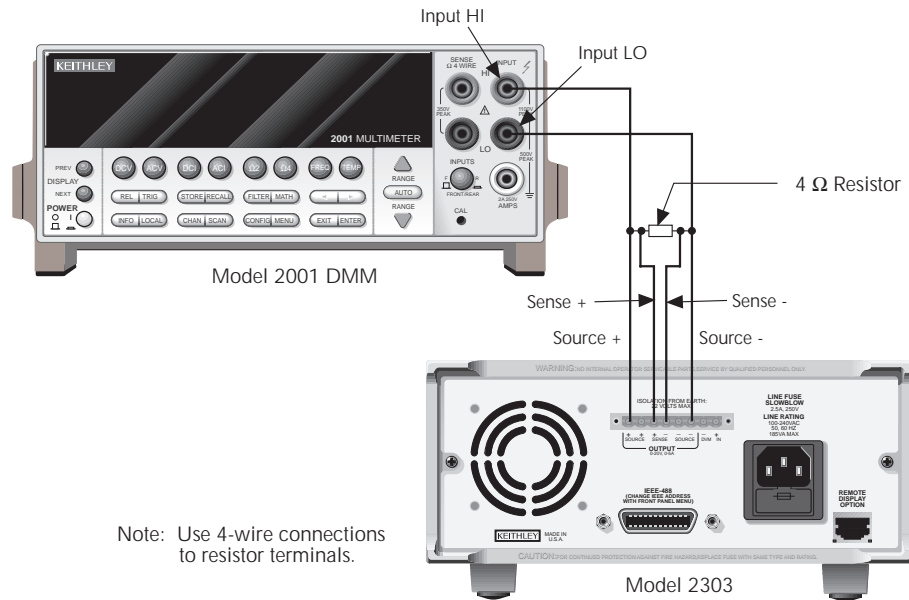

Figure 2-3
Connections for 5A current calibration

10. At this point, the unit will prompt for 5A full-scale calibration output:
SOURCE 5 AMPS
SET 1.90000 A
11. Using the edit keys, adjust the set value to 1.9000A, then press ENTER. The unit will then prompt you for the DMM reading, which calibrates the 5A current limit:
SOURCE 5 AMPS
READ1 1.90000 A
12. Note the DMM voltage reading, then calculate the current from that reading and the actual 4Ω resistance value: $I = V/R$. Adjust the Model 2303 current display value to agree with the calculated current value, and press ENTER.

13. The Model 2303 will then prompt for another DMM reading, which is used for 5A measurement calibration:
SOURCE 5 AMPS
READ2 1.90000 A
14. Again, calculate the current from the new DMM reading and 4Ω resistor value. Adjust the 2303 current display reading to agree with the new current, then press ENTER.
15. Disconnect the 4Ω resistor, then connect the $3k\Omega$ resistor in its place. (See Figure 2-4.)

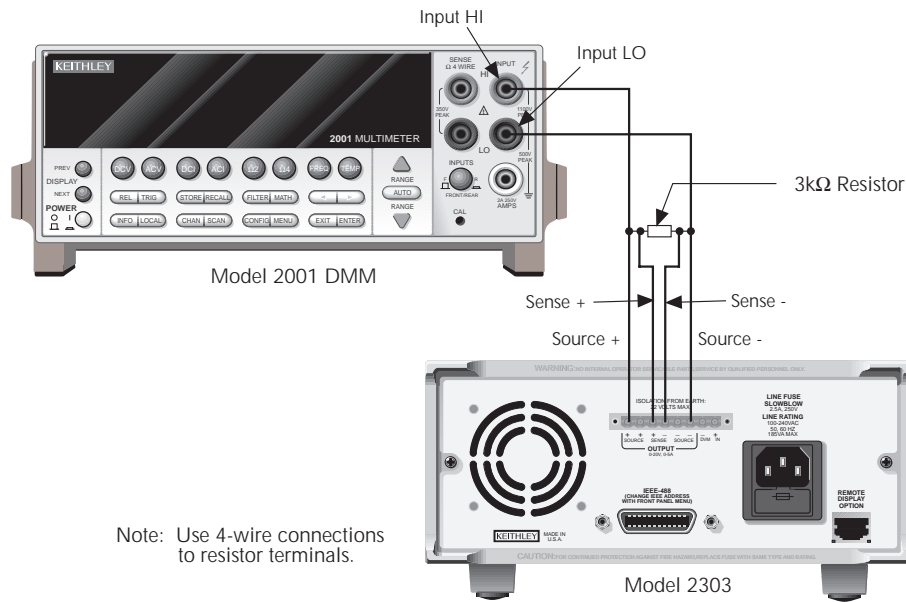

Figure 2-4
Connections for 5mA range calibration

16. Make sure the DMM DC volts function and auto-ranging are still selected.
17. At this point, the unit will prompt to output approximately 5mA for 5mA range full-scale calibration:
SOURCE 5 mA
ALL READY TO DO?
18. Press ENTER to output approximately 5mA. The unit will then prompt you for the DMM reading:
SOURCE 5 mA
READ1 4.50000 mA

19. Note the DMM voltage reading, then calculate the current from that voltage reading and actual $3\text{k}\Omega$ resistance value. Adjust the Model 2303 current display value to agree with that value, and press ENTER.

Table 2-2*Model 2303 front panel calibration summary*

Step*	Description	Nominal calibration signal**	Test connections
0	Output 14V	14V	Figure 2-2
1	Full-scale output voltage	14V	Figure 2-2
2	Full-scale measure	14V	Figure 2-2
3	Full-scale DVM	14V	Figure 2-2
4	5A range output current	1.9A	Figure 2-3
5	5A current limit	1.9A	Figure 2-3
6	5A measure	1.9A	Figure 2-3
7	5mA range output current	4.5mA	Figure 2-4
8	5mA measure	4.5mA	Figure 2-4

* Step numbers correspond to :CAL:PROT:STEP command numbers. See Table 2-3.

** Factory default display values.

Step 3: Enter calibration dates, and save calibration

1. After completing all calibration steps, the unit will prompt if you wish to save calibration:
CALIBRATE UNIT
Save Cal Data YES
2. To save new calibration constants, select YES, then press ENTER. If, on the other hand, you wish to exit calibration without saving new calibration constants, select NO, then press ENTER. In that case, the unit will revert to prior calibration constants.
3. The unit will then prompt you to enter the calibration date:
CALIBRATE UNIT
Cal Date 02/01/98
4. Using the edit keys, set the calibration date to today's date, then press ENTER. The unit will display the following:
CALIBRATE UNIT
EXITING CAL
5. Press ENTER to complete the calibration procedure and return to the menu display. Calibration is now complete.

Model 2303-PJ front panel calibration

Use the following procedure to calibrate the Model 2303-PJ from the front panel. Table 2-3 summarizes the calibration steps.

NOTE *Calibration must be performed in the following sequence, or an error will occur. To abort calibration and revert to previous calibration constants at any time during the procedure, press the MENU key.*

Step 1: Prepare the Model 2303-PJ for calibration

1. Turn on the Model 2303 and the digital multimeter, and allow them to warm up for at least one hour before performing calibration.
2. Press the MENU key, then choose CALIBRATE UNIT, and press ENTER. The instrument will display the date last calibrated:
CALIBRATE UNIT
LAST ON 02/01/98
3. Press the up arrow key. The instrument will display the number of times it was calibrated:
CALIBRATE UNIT
TIMES= 01
4. Press the up arrow key. The unit will then prompt you to run calibration:
CALIBRATE UNIT
RUN
5. Press ENTER. The unit will then prompt for the calibration code:
CALIBRATE UNIT
Cal Code KI002303
6. Using the edit keys, set the display to the current calibration code, then press ENTER. (Default: KI002303.) The unit will then prompt you as to whether or not to change the code:
CALIBRATE UNIT
Change Code NO
7. Be sure NO is selected (use the up and down arrow keys), press ENTER, then follow the steps below to calibrate the unit. (See *Changing the calibration code* at the end of this section if you wish to change the code.)

Step 2: Perform calibration steps

NOTE *The unit will display the most recently calibrated values. Factory defaults are shown in this manual.*

1. Connect both the OUTPUT SOURCE and DVM IN terminals to the digital multimeter, as shown in Figure 2-2. (Connect SOURCE + and DVM IN + to DMM INPUT HI; connect SOURCE - and DVM IN - to DMM INPUT LO.)

2. At this point, the Model 2303 will prompt you to set the full-scale output voltage:
FULL SCALE VOLTS
SET 14.0000 V
3. Use the edit keys to set the voltage to 14.0000V, then press ENTER.

NOTE *At this point, the source output is turned on and will remain on until calibration is complete or aborted with the MENU key.*

4. The unit will prompt you for the DMM reading, which will be used to calibrate the full-scale output voltage:
FULL SCALE VOLTS
READ1 14.0000 V
5. Using the edit keys, adjust the Model 2303-PJ voltage display to agree with the DMM voltage reading, then press ENTER. The unit will then prompt for another DMM reading, which will be used to calibrate the full-scale measurement function:
FULL SCALE VOLTS
READ2 14.0000 V
6. Using the edit keys, adjust the display to agree with the new DMM voltage reading, then press ENTER. The unit will then prompt for DVM full-scale calibration:
FULL SCALE DVM
ALL READY TO DO?
7. Press ENTER to complete DVM full-scale calibration.
8. Connect the digital multimeter volts input and characterized 4Ω resistor to the Model 2303-PJ OUTPUT SOURCE terminals, as shown in Figure 2-3. Be sure to observe proper polarity (SOURCE + to DMM INPUT HI; SOURCE - to INPUT LO).
9. Be sure the digital multimeter DC volts function and auto-ranging are still selected.
10. At this point, the unit will prompt for 5A full-scale calibration output:
SOURCE 5 AMPS
SET 1.90000 A
11. Using the edit keys, adjust the set value to 1.9000A, then press ENTER. The unit will then prompt you for the DMM reading, which calibrates the 5A current limit:
SOURCE 5 AMPS
READ1 1.90000 A
12. Note the DMM voltage reading, then calculate the current from that reading and the actual 4Ω resistance value: $I = V/R$. Adjust the Model 2303-PJ current display value to agree with the calculated current value, and press ENTER.
13. The Model 2303-PJ will then prompt for another DMM reading, which is used for 5A measurement calibration:
SOURCE 5 AMPS
READ2 1.90000 A
14. Again, calculate the current from the new DMM reading and 4Ω resistor value. Adjust the 2303 current display reading to agree with the new current, then press ENTER.

15. Disconnect the 4Ω resistor, then connect the characterized 30Ω resistor in its place. (See Figure 2-5.)

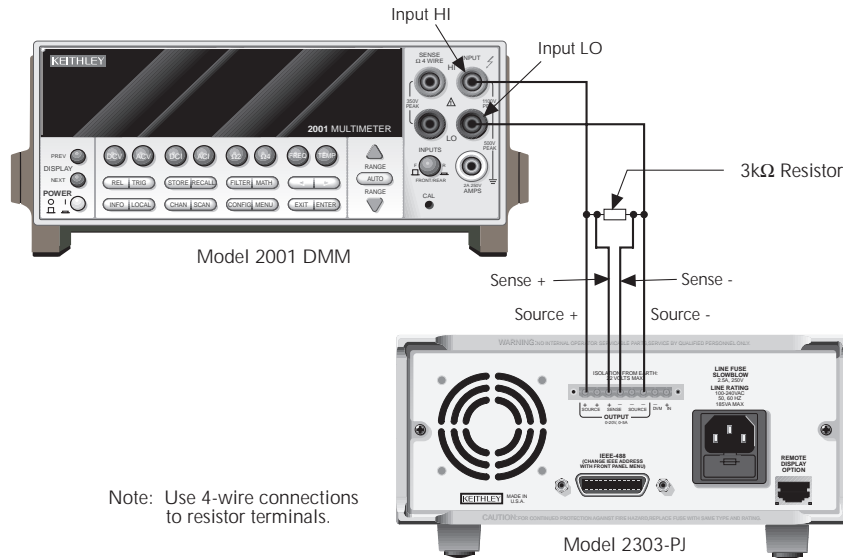

Figure 2-5
Connections for 500mA range calibration

16. Make sure the DMM DC volts function and auto-ranging are still selected.
17. At this point, the unit will prompt to output approximately 500mA for 500mA range full-scale calibration:
SOURCE 500 mA
ALL READY TO DO?
18. Press ENTER to output approximately 500mA. The unit will then prompt you for the DMM reading:
SOURCE 500 mA
READ1 450.000 mA
19. Note the DMM voltage reading, then calculate the current from that voltage reading and actual 30Ω resistance value. Adjust the Model 2303-PJ current display value to agree with that value, and press ENTER.

Table 2-3*Model 2303-PJ front panel calibration summary*

Step*	Description	Nominal calibration signal**	Test connections
0	Output 14V	14V	Figure 2-2
1	Full-scale output voltage	14V	Figure 2-2
2	Full-scale measure	14V	Figure 2-2
3	Full-scale DVM	14V	Figure 2-2
4	5A range output current	1.9A	Figure 2-3
5	5A current limit	1.9A	Figure 2-3
6	5A measure	1.9A	Figure 2-3
7	500mA range output current	450mA	Figure 2-5
8	500mA measure	450mA	Figure 2-5

* Step numbers correspond to :CAL:PROT:STEP command numbers.

** Factory default display values.

Step 3: Enter calibration dates, and save calibration

- After completing all calibration steps, the unit will prompt if you wish to save calibration:
CALIBRATE UNIT
Save Cal Data YES
- To save new calibration constants, select YES, then press ENTER. If, on the other hand, you wish to exit calibration without saving new calibration constants, select NO, then press ENTER. In that case, the unit will revert to prior calibration constants.
- The unit will then prompt you to enter the calibration date:
CALIBRATE UNIT
Cal Date 02/01/98
- Using the edit keys, set the calibration date to today's date, then press ENTER. The unit will display the following:
CALIBRATE UNIT
EXITING CAL
- Press ENTER to complete the calibration procedure and return to the menu display. Calibration is now complete.

Remote calibration

Follow the procedure outlined below to perform Model 2303, 2303B, and 2303-PJ remote calibration by sending SCPI commands over the IEEE-488 bus. The remote commands and appropriate parameters are separately summarized for each step.

Remote calibration commands

Table 2-4 summarizes remote calibration commands. For a more complete description of these commands, refer to Appendix B.

Table 2-4
Remote calibration command summary

Command	Description
:CALibration	Calibration subsystem.
:PROTeCted	Cal commands protected by password.
:CODE '<code>'	Unlock cal; changes code if cal is already unlocked. (Default code: KI002303.)
:COUNt?	Query number of times 2303 has been calibrated.
:DATE <yyyy>,<mm>,<dd>	Program calibration year, month, day.
:DATE?	Query calibration year, month, day.
:INIT	Initiate calibration (must be sent before other cal steps).
:SAVE	Save calibration data to EEPROM.*
:LOCK	Lock out calibration. (Abort if calibration is incomplete.)
:STEP0 <nrf>	Output full-scale voltage (14V).
:STEP1 <nrf>	Calibrate output voltage setting using external DMM reading.
:STEP2 <nrf>	Calibrate voltage measuring using external DMM reading.
:STEP3	Perform DVM input full-scale (14V) cal.
:STEP4 <nrf>	Output current (1.9A) for 5A full-scale cal.
:STEP5 <nrf>	Calibrate output current limit using calculated current.
:STEP6 <nrf>	Calibrate 5A measurement range using calculated current.
:STEP7	Output 5mA (500mA, Model 2303-PJ) nominal current for 5mA (500mA) range full-scale cal.
:STEP8 <nrf>	Calibrate 5mA (500mA, Model 2303-PJ) measurement range using calculated current.

* Calibration data will not be saved if:

1. Calibration was not unlocked with :CODE command.
2. Invalid data exists. (For example, cal step failed or was aborted.)
3. Incomplete number of cal steps were performed.
4. Calibration was not performed in the proper sequence.

Remote calibration display

The Model 2303 and Model 2303-PJ will display the following while being calibrated over the bus:

```
CALIBRATING UNIT
FROM THE BUS R
```

Models 2303 and 2303B remote calibration procedure

Use the following procedure to calibrate the Models 2303 and 2303B. Table 2-5 summarizes the calibration steps.

NOTE Calibration steps must be performed in the following sequence, or an error will occur. You can abort the procedure and revert to previous calibration constants before :SAVE by sending the :CAL:PROT:LOCK command.

Step 1: Prepare the Model 2303 for calibration

1. Connect the Model 2303 to the controller IEEE-488 interface using a shielded interface cable.
2. Turn on the Model 2303 and the test equipment, and allow them to warm up for at least one hour before performing calibration.
3. Make sure the IEEE-488 primary address of the Model 2303 is the same as the address specified in the program you will be using to send commands.
4. Send the following command with the correct code to unlock calibration:
:CAL:PROT:CODE '<code>'

For example, with the factory default code of KI002303, send:

```
CAL:PROT:CODE 'KI002303'
```

5. Send the following command to initiate calibration:
:CAL:PROT:INIT

Step 2: Perform calibration steps

NOTE Allow the Model 2303 to complete each calibration step before going on to the next one. See Detecting calibration step completion in Appendix B.

1. Connect both the OUTPUT SOURCE and DVM IN terminals to the digital multimeter, as shown in Figure 2-2. (Connect SOURCE + and DVM IN + to DMM INPUT HI; SOURCE - and DVM IN - to DMM INPUT LO.)
2. Send the following command to output 14V:
:CAL:PROT:STEP0 14

NOTE At this point, the source output is turned on and will remain on until calibration is completed or aborted with the `:CAL:PROT:LOCK` command.

3. Note and record the DMM reading, then send that reading as the parameter for the following command:
`:CAL:PROT:STEP1 <DMM_Reading>`
For example, if the DMM reading is 14.012V, the command would be:
`:CAL:PROT:STEP1 14.012`
4. Note and record a new DMM reading, then send that reading as the parameter for the following command:
`:CAL:PROT:STEP2 <DMM_Reading>`
5. Send the following command for DVM full-scale calibration:
`:CAL:PROT:STEP3`
6. Connect the Model 2303 OUTPUT SOURCE terminals to the DMM volts input and characterized 4Ω resistor, as shown in Figure 2-3. Be sure to observe proper polarity (SOURCE + to INPUT HI; SOURCE - to INPUT LO).
7. Make sure the digital multimeter DC volts function and auto-ranging are still selected.
8. Send the following command to output 1.9A for 5A full-scale calibration:
`:CAL:PROT:STEP4 1.9`
9. Note and record the DMM voltage reading, then calculate the current from that reading and 4Ω resistor value. Send the following command using that calculated current as the parameter:
`:CAL:PROT:STEP5 <Calculated_Current>`
For example, with a current value of 1.894A, the command would appear as follows:
`:CAL:PROT:STEP5 1.894`
10. Note and record a new DMM voltage reading, then again calculate the current from the voltage and resistance. Send the calculated current value as the parameter for the following command:
`:CAL:PROT:STEP6 <Calculated_Current>`
11. Connect the characterized $3k\Omega$ resistor in place of the 4Ω resistor. (See Figure 2-4.)
12. Make sure the DMM DC volts function and auto-range are still selected.
13. Send the following command to output approximately 5mA for 5mA full-scale calibration:
`:CAL:PROT:STEP7`
14. Note and record the DMM voltage reading, then calculate the current from the voltage reading and actual $3k\Omega$ resistance value. Send that current value as the parameter for the following command:
`:CAL:PROT:STEP8 <Calculated_Current>`
For example, with a current of 4.5mA, the command would be:
`:CAL:PROT:STEP8 4.5E-3`

Table 2-5
Models 2303 and 2303B remote calibration summary

Step*	Command	Description	Test connections
	:CAL:PROT:CODE 'KI002303'	Unlock calibration.	None
	:CAL:PROT:INIT	Initiate calibration.	None
0	:CAL:PROT:STEP0 14	Full-scale (14V) output	Figure 2-2
1	:CAL:PROT:STEP1 <DMM_Reading>	Full-scale output cal.	Figure 2-2
2	:CAL:PROT:STEP2 <DMM_Reading>	Full-scale measure cal.	Figure 2-2
3	:CAL:PROT:STEP3	DVM full-scale cal.	Figure 2-2
4	:CAL:PROT:STEP4 1.9	Source full-scale current cal.	Figure 2-3
5	:CAL:PROT:STEP5 <Current>	5A current limit cal.	Figure 2-3
6	:CAL:PROT:STEP6 <Current>	5A measure cal.	Figure 2-3
7	:CAL:PROT:STEP7	Source 5mA full-scale current.	Figure 2-4
8	:CAL:PROT:STEP8 <Current>	5mA range measure cal.	Figure 2-4
	:CAL:PROT:DATE <yyyy,mm,dd>	Program calibration date.	None
	:CAL:PROT:SAVE	Save calibration data.	None
	:CAL:PROT:SAVE	Lock out calibration.	None

* Step numbers correspond to :STEP commands.

Step 3: Program calibration date

Use following commands to set the calibration date:

```
:CAL:PROT:DATE <yyyy>, <mm>, <dd>
```

Note that the year, month, and date must be separated by commas. The allowable range for the year is from 1997 to 2096, the month is from 1 to 12, and the date is from 1 to 31.

Step 4: Save calibration constants and lock out calibration

Calibration is now complete, so you can store the calibration constants in EEROM by sending the following command:

```
:CAL:PROT:SAVE
```

NOTE Calibration will be temporary unless you send the SAVE command. Also, calibration data will not be saved if (1) calibration is locked, (2) invalid data exists, or (3) all steps were not completed in the proper sequence. In that case, the unit will revert to previous calibration constants.

After saving constants, lock out calibration by sending :CAL:PROT:LOCK.

Model 2303-PJ remote calibration procedure

Follow the steps below to calibrate the Model 2303-PJ via remote. Table 2-6 summarizes these steps.

NOTE Calibration steps must be performed in the following sequence, or an error will occur. You can abort the procedure and revert to previous calibration constants before :SAVE by sending the :CAL:PROT:LOCK command.

Step 1: Prepare the Model 2303-PJ for calibration

1. Connect the Model 2303-PJ to the controller IEEE-488 interface using a shielded interface cable.
2. Turn on the Model 2303-PJ and the test equipment, and allow them to warm up for at least one hour before performing calibration.
3. Make sure the IEEE-488 primary address of the Model 2303-PJ is the same as the address specified in the program you will be using to send commands.
4. Send the following command with the correct code to unlock calibration:
:CAL:PROT:CODE '<code>'

For example, with the factory default code of KI002303, send:

```
CAL:PROT:CODE 'KI002303'
```

5. Send the following command to initiate calibration:
:CAL:PROT:INIT

Step 2: Perform calibration steps

NOTE Allow the Model 2303-PJ to complete each calibration step before going on to the next one. See Detecting calibration step completion in Appendix B.

1. Connect both the OUTPUT SOURCE and DVM IN terminals to the digital multimeter, as shown in Figure 2-2. (Connect SOURCE + and DVM IN + to DMM INPUT HI; SOURCE - and DVM IN - to DMM INPUT LO.)
2. Send the following command to output 14V:
:CAL:PROT:STEP0 14

NOTE At this point, the source output is turned on and will remain on until calibration is completed or aborted with the :CAL:PROT:LOCK command.

3. Note and record the DMM reading, then send that reading as the parameter for the following command:
:CAL:PROT:STEP1 <DMM_Reading>
For example, if the DMM reading is 14.012V, the command would be:
:CAL:PROT:STEP1 14.012
4. Note and record a new DMM reading, then send that reading as the parameter for the following command:
:CAL:PROT:STEP2 <DMM_Reading>

5. Send the following command for DVM full-scale calibration:
:CAL:PROT:STEP3
6. Connect the Model 2303-PJ OUTPUT SOURCE terminals to the DMM volts input and characterized 4Ω resistor, as shown in Figure 2-3. Be sure to observe proper polarity (SOURCE + to INPUT HI; SOURCE - to INPUT LO).
7. Make sure the digital multimeter DC volts function and auto-ranging are still selected.
8. Send the following command to output 1.9A for 5A full-scale calibration:
:CAL:PROT:STEP4 1.9
9. Note and record the DMM voltage reading, then calculate the current from that reading and 4Ω resistor value. Send the following command using that calculated current as the parameter:
:CAL:PROT:STEP5 <Calculated_Current>
For example, with a current value of 1.894A, the command would appear as follows:
:CAL:PROT:STEP5 1.894
10. Note and record a new DMM voltage reading, then again calculate the current from the voltage and resistance. Send the calculated current value as the parameter for the following command:
:CAL:PROT:STEP6 <Calculated_Current>
11. Connect the characterized 30Ω resistor in place of the 4Ω resistor. (See Figure 2-5.)
12. Make sure the DMM DC volts function and auto-range are still selected.
13. Send the following command to output approximately 500mA for 500mA full-scale calibration:
:CAL:PROT:STEP7
14. Note and record the DMM voltage reading, then calculate the current from the voltage reading and actual 30Ω resistance value. Send that current value as the parameter for the following command:
:CAL:PROT:STEP8 <Calculated_Current>
For example, with a current of 450mA, the command would be:
:CAL:PROT:STEP8 450E-3

Table 2-6
Model 2303-PJ remote calibration summary

Step*	Command	Description	Test connections
	:CAL:PROT:CODE 'KI002303'	Unlock calibration.	None
	:CAL:PROT:INIT	Initiate calibration.	None
0	:CAL:PROT:STEP0 14	Full-scale (14V) output	Figure 2-2
1	:CAL:PROT:STEP1 <DMM_Reading>	Full-scale output cal.	Figure 2-2
2	:CAL:PROT:STEP2 <DMM_Reading>	Full-scale measure cal.	Figure 2-2
3	:CAL:PROT:STEP3	DVM full-scale cal.	Figure 2-2
4	:CAL:PROT:STEP4 1.9	Source full-scale current cal.	Figure 2-3
5	:CAL:PROT:STEP5 <Current>	5A current limit cal.	Figure 2-3
6	:CAL:PROT:STEP6 <Current>	5A measure cal.	Figure 2-3
7	:CAL:PROT:STEP7	Source 500mA full-scale current.	Figure 2-5
8	:CAL:PROT:STEP8 <Current>	500mA range measure cal.	Figure 2-5
	:CAL:PROT:DATE <yyyy,mm,dd>	Program calibration date.	None
	:CAL:PROT:SAVE	Save calibration data.	None
	:CAL:PROT:SAVE	Lock out calibration.	None

* Step numbers correspond to :STEP commands.

Step 3: Program calibration date

Use following commands to set the calibration date:

```
:CAL:PROT:DATE <yyyy>, <mm>, <dd>
```

Note that the year, month, and date must be separated by commas. The allowable range for the year is from 1997 to 2096, the month is from 1 to 12, and the date is from 1 to 31.

Step 4: Save calibration constants and lock out calibration

Calibration is now complete, so you can store the calibration constants in EEROM by sending the following command:

```
:CAL:PROT:SAVE
```

NOTE Calibration will be temporary unless you send the SAVE command. Also, calibration data will not be saved if (1) calibration is locked, (2) invalid data exists, or (3) all steps were not completed in the proper sequence. In that case, the unit will revert to previous calibration constants.

After saving constants, lock out calibration by sending :CAL:PROT:LOCK.

Changing the calibration code

The default calibration code may be changed from the front panel (Model 2303 and 2303-PJ only) or via remote (Models 2303, 2303B, and 2303-PJ) as discussed below.

Changing the code from the front panel

Follow the steps below to change the Model 2303 or 2303-PJ code from the front panel:

1. Press the MENU key, then choose CALIBRATE UNIT, and press ENTER. The instrument will display the last date calibrated:
CALIBRATE UNIT
LAST ON 02/01/97
2. Press the up arrow key. The instrument will display the number of times it was calibrated:
CALIBRATE UNIT
TIMES= 01
3. Press the up arrow key. The unit will then prompt you to run calibration:
CALIBRATE UNIT
RUN
4. Press ENTER. The unit will then prompt for the calibration code:
CALIBRATE UNIT
Cal Code KI002303
5. Using the edit keys, set the display to the current present calibration code, then press ENTER. (Default: KI002303.) The unit will then prompt you as to whether or not to change the code:
CALIBRATE UNIT
Change Code NO
6. Select YES, then press ENTER. The instrument will then prompt you to change the code:
CALIBRATE UNIT
New Code: KI002303
7. Use the edit keys to set the new code, then press ENTER to accept the new code.
8. Press the MENU key to exit calibration and return to the main menu.

Changing the code by remote

To change the Model 2303, 2303B, or 2303-PJ calibration code by remote, first send the present code, then send the new code. For example, the following command sequence changes the code from the 'KI002303' remote default to 'KI_CAL':

```
:CAL:PROT:CODE 'KI002303'
```

```
:CAL:PROT:CODE 'KI_CAL'
```

You can use any combination of letters and numbers up to a maximum of eight characters.

Resetting the calibration code

If you lose the calibration code, you can unlock calibration by temporarily shorting together the CAL pads, which are located on the digital board, while turning on the power. Since the digital board is located under the analog board, it may be necessary to use extender wires or to remove the analog board to gain access.

Viewing calibration date and count

Viewing date and count from the front panel

Follow the steps below to view the Model 2303 or 2303-PJ calibration date and count from the front panel:

1. Press the MENU key, then choose CALIBRATE UNIT, and press ENTER. The instrument will display the last date calibrated:
CALIBRATE UNIT
LAST ON 02/01/97
2. Press the up arrow key. The instrument will display the number of times it was calibrated:
CALIBRATE UNIT
TIMES= 01
3. Press MENU to return to the menu structure.

Acquiring date and count by remote

Use the :DATE? and :COUNT? queries to determine the Model 2303, 2303B, or 2303-PJ calibration date and count respectively. See *Miscellaneous commands* in *Appendix B* for more details.

3 Disassembly

Introduction

This section explains how to handle, clean, and disassemble the Models 2303, 2303B, and 2303-PJ. Disassembly drawings are located at the end of this section.

WARNING **The procedures in this section are intended only for qualified service personnel. Disconnect the line cord and all test leads and wires from the instrument before disassembling the unit.**

Handling and cleaning

To avoid contaminating PC board traces with body oil or other foreign matter, avoid touching the PC board traces while you are repairing the instrument. Some circuit board areas have high-impedance devices or sensitive circuitry where contamination could cause degraded performance.

Handling PC boards

Observe the following precautions when handling PC boards:

- Wear cotton gloves.
- Only handle PC boards by the edges and shields.
- Do not touch any board traces or components not associated with repair.
- Do not touch areas adjacent to electrical contacts.
- Use dry nitrogen gas to clean dust off PC boards.

Solder repairs

Observe the following precautions when soldering a circuit board:

- Use an OA-based (organic activated) flux, and take care not to spread the flux to other areas of the circuit board.
- Remove the flux from the work area when you have finished the repair by using pure water with clean, foam-tipped swabs or a clean, soft brush.
- Once you have removed the flux, swab only the repair area with methanol, then blow dry the board with dry nitrogen gas.
- After cleaning, allow the board to dry in a 50°C, low-humidity environment for several hours.

Static sensitive devices

CMOS devices operate at very high impedance levels. Therefore, any static that builds up on you or your clothing may be sufficient to destroy these devices if they are not handled properly. Use the following precautions to avoid damaging them:

CAUTION Many CMOS devices are installed in the Model 2303. Handle all semiconductor devices as being static sensitive.

- Transport and handle ICs only in containers specially designed to prevent static build-up. Typically, you will receive these parts in anti-static containers made of plastic or foam. Keep these devices in their original containers until ready for installation.
- Remove the devices from their protective containers only at a properly grounded work station. Also, ground yourself with a suitable wrist strap.
- Handle the devices only by the body; do not touch the pins.
- Ground any printed circuit board into which a semiconductor device is to be inserted to the bench or table.
- Use only anti-static type desoldering tools.
- Use only grounded-tip solder irons.
- Once the device is installed in the PC board, it is normally adequately protected, and you can handle the boards normally.

Assembly drawings

Use the assembly drawings located at the end of this section to assist you as you disassemble and re-assemble the Model 2303. Also, refer to these drawings for information about the Keithley part numbers of most mechanical parts in the unit.

Assembly drawings include:

- Front Panel Assembly — 2303-040, 2303B-040, 2303-PJ-040
- Chassis Assembly — 2303-050, 2303B-050
- Analog Board To Chassis Assembly — 2303-051, 2303B-051, 2303-PJ-051
- Final Chassis Assembly — 2303-052, 2303B-052, 2303-PJ-052

Disassembly procedures

Case cover removal

Follow the steps below to remove the case cover to gain access to internal parts.

WARNING Before removing the case cover, disconnect the line cord and any test leads from the instrument.

1. Remove Handle — The handle serves as an adjustable tilt-bail. Adjust its position by gently pulling it away from the sides of the instrument case and swinging it up or down. To remove the handle, swing the handle below the bottom surface of the case and back until the orientation arrows on the handles line up with the orientation arrows on the mounting ears. With the arrows lined up, pull the ends of the handle away from the case.

2. Remove Mounting Ears — Remove the screw that secures each mounting ear. Pull down and out on each mounting ear.

NOTE When re-installing the mounting ears, make sure to mount the right ear to the right side of the chassis, and the left ear to the left side of the chassis. Each ear is marked “RIGHT” or “LEFT” on its inside surface.

3. Remove Rear Bezel — To remove the rear bezel, loosen the two screws that secure the rear bezel to the chassis, then pull the bezel away from the case.
4. Removing Grounding Screws — Remove the two grounding screws that secure the case to the chassis. They are located on the bottom of the case at the back.
5. Remove Chassis — To remove the case, grasp the front of the instrument, and carefully slide the case off the chassis to the rear.

Analog board removal

Perform the following steps to remove the analog board. This procedure assumes that the case cover is already removed.

1. Unplug all cables connected to the analog board.
2. Remove the six screws that secure the analog board to the chassis.
3. After all screws have been removed, carefully lift the analog board assembly free of the main chassis.

Digital board removal

Perform the following steps to remove the digital board. This procedure assumes that the analog board assembly has already been removed.

1. Remove the IEEE-488 connector fasteners that attach the connector to the rear panel.
2. To remove the POWER switch rod, place the edge of a flat-blade screw driver in the notch on the pushrod, then gently twist the screw driver while pulling the rod from the shaft.
3. Disconnect all cables and wires connected to the digital board.
4. Remove the front panel by prying out the four retaining clips while pulling the front panel away from the chassis.
5. Remove the digital board by sliding it forward until it is free of the guide pins, then slide the board forward toward the front of the chassis until it can be pulled free.

During re-assembly, replace the board, and start the IEEE-488 connector nuts. Tighten all the fasteners once they are all in place and the board is correctly aligned.

Front panel disassembly

Follow the steps below to disassemble the front panel (Models 2303 and 2303-PJ only). The procedure assumes that the front panel has already been removed from the chassis as described above.

1. Remove the four screws that secure the display board to the front panel.

2. Remove the display board from the front panel.

Removing mechanical components

The following procedures to remove the fan and line filter require that the case cover, front panel, and digital and analog circuit boards have been removed, as previously explained.

Fan removal

Perform the following steps to remove the fan:

1. Remove the four screws that secure the fan to the rear panel.
2. Remove the fan from the chassis.

Line filter removal

To remove the line filter, squeeze the latches on either side while pushing the line filter from the access hole on the rear panel.

Instrument re-assembly

Re-assemble the instrument by reversing the previous disassembly procedures. Make sure that all parts are properly seated and secured, and that all connections are properly made.

WARNING To ensure continued protection against electrical shock, verify that power line ground (green and yellow wire attached to the line filter module) is connected to the chassis. Also make certain that the two bottom case screws are properly installed to secure and ground the case cover to the chassis.

Introduction

This section contains replacement parts information for both the Models 2303, 2303B, and 2303-PJ.

Ordering information

To place an order, or to obtain information concerning replacement parts, contact your Keithley representative or the factory. When ordering parts, be sure to include the following information:

- Instrument model number (Model 2303, 2303B, or 2303-PJ)
- Instrument serial number
- Part description
- Component designation (if applicable)
- Keithley part number

Factory service

If the instrument is to be returned to Keithley Instruments for repair, perform the following:

- Call the Repair Department at 1-800-552-1115 for a Return Material Authorization (RMA) number.
- Complete the service form at the back of this manual, and include it with the instrument.
- Carefully pack the instrument in the original packing carton or equivalent.
- Write ATTENTION REPAIR DEPARTMENT and the RMA number on the shipping label.

Parts lists and component layouts

The parts lists for the Models 2303, 2303B, and 2303-PJ are listed separately in tables on the following pages. For part numbers to the various mechanical parts and assemblies, use the assembly drawings provided at the end of *Section 3*. Component layout drawings are provided at the end of this section:

- Digital board – 2303-100
- Analog board – 2303-120
- Display board – 2304-110

Models 2303 and 2303-PJ parts lists

Table 4-1

Models 2303 and 2303-PJ digital board parts list

Circuit designation	Description	Keithley part no.
C100,111,117,122,124,128,151-153,213	CAP, .1UF, 20%, 50V, CERAMIC	C-418-.1
C101,C102,C105,C115	CAP, .1UF, 10%, 25V, CERAMIC	C-495-.1
C106,C150,C265	CAP, 1000PF, 10%, 50V, MONO CERAMIC	C-452-1000P
C107,C108,C129,C133	CAP, 22U, 20%, 25V, TANTALUM	C-535-22
C109,C184	CAP, 1000PF, 20%, 50V, CERAMIC	C-418-1000P
C110,C112,C116,C120,C130,C141,C161, C162	CAP, .01UF, 10%, 50V, CERAMIC	C-491-.01
C113	CAP, 68PF, 10%, 100V, CERAMIC	C-451-68P
C114,C145	CAP, 22PF, 10%, 100V, CERAMIC	C-451-22P
C118,C138	CAP, 2200P, 1%, 50V, CERAMIC	C-532-2200P
C119,C148,C156	CAP, 100PF, 5%, 100V, CERAMIC	C-465-100P
C123,134,269,139,147	CAP, 10UF,20%, 25V, TANTALUM	C-440-10
C125,126,274,149,154,155,196,275	CAP, .1UF, 10%, 25V, CERAMIC	C-495-.1
C127,C146	CAP, 470P, 10%, 100V, CERAMIC	C-451-470P
C135,C266	CAP, 2.2U, 10%, 50V, TANTALUM	C-563-2.2
C136,157,165,189,193,282,204,121,103	CAP, .1UF, 20%, 50V, CERAMIC	C-418-.1
C143	CAP, 270PF, 5%, 100V, CERAMIC	C-465-270P
C158	CAP, .01UF, 20%, 50V, CERAMIC	C-418-.01
C159	CAP, .022UF, 10%, 50V, CERAMIC	C-491-.022
C160,142,166,197,264,276	CAP, 22UF, 20%, 25V, TANTALUM	C-440-22
C163,C190,C195	CAP, .01UF, 10%, 50V, CERAMIC	C-491-.01
C167	CAP, 4700PF, 20%, 50V, CERAMIC	C-418-4700P
C171,C188	CAP, 47P, 5%, 100V, CERAMIC	C-465-47P
C173,C183	CAP, 2200P, 10%, 100V, CERAMIC	C-430-2200P
C179,C185,C212,C214	CAP, 1000P, 10%, 100V, CERAMIC	C-451-1000P
C181	CAP, 220UF, +/-20%, 50V, ALUM ELEC	C-507-220
C191,C192,C168	CAP, 15P, 1%, 100V, CERAMIC	C-512-15P
C194	CAP, .1UF, 10%, 25V, CERAMIC	C-495-.1
C215-222,225-230,238,241,244,246-248	CAP, .1UF, 20%, 50V, CERAMIC	C-418-.1
C223,C224,C273	CAP, .47U, 20%, 25V	C-520-.47
C233,C234,C235	CAP, .1UF, 20%, 50V, CERAMIC	C-418-.1
C236,C239,C277	CAP, 1UF, 20%, 35V, TANTALUM	C-494-1
C237,C240	CAP, 22PF, 10%, 100V, CERAMIC	C-451-22P
C245,C249,C258,C164	CAP, 47P, 5%, 100V, CERAMIC	C-465-47P
C250,C251	CAP, .01UF, 10%, 50V, CERAMIC	C-491-.01

Table 4-1 (continued)

Models 2303 and 2303-PJ digital board parts list

Circuit designation	Description	Keithley part no.
C252,253,255-257,259-263,271,169,270	CAP, .1UF, 20%, 50V, CERAMIC	C-418-.1
C254	CAP, 100PF, 5%, 100V, CERAMIC	C-465-100P
C280,281,172,174-177,180,182,186,187	CAP, .1UF, 10%, 25V, CERAMIC	C-495-.1
C285	CAP, .15UF, 20%,50V, CERAMIC	C-418-.15
C286	CAP, .047U, 10%, 50V, CERAMIC	C-491-.047
C288,C289	CAP, .1UF, 20%, 50V, CERAMIC	C-418-.1
C293	CAP, .01UF, 20%, 50V, CERAMIC	C-418-.01
C294,C284	CAP, .47, 10% 16V, CERAMIC	C-565-.47
CR100,CR101,CR110,CR111	DIODE, SWITCHING, MMSD914T19	RF-112
CR104	DIODE, DUAL HSM-2822T31	RF-95
J1002	CONN, MOLEX, 3-PIN	CS-772-3
J1003	CONN, RIGHT ANGLE,24PIN	CS-507
J1005	SHIELDED RT. ANGLE PHONE JACK	CS-981
J1006, J1013,J1015	LATCHING HEADER, FRICTON, SGL ROW	CS-724-3
L101	EMI SUPPRESSION INDUCTOR	CH-84
L103,L104,L105,L109	FERRITE CHIP 600 OHM BLM32A07	CH-62
L106,L107,L108	FERRITE CHIP 600 OHM BLM32A07	CH-62
P1007	CABLE ASSEMBLY, 26 CONDUCTOR	CA-27-6
P1008	CABLE ASSEMBLY WITH GROUND PLANE	CA-152-2B
P1009	CABLE ASSEMBLY	CA-62-4B
P1010	CABLE ASSEMBLY	CA-171-1A
PS100	POWER SUPPLY	PS-64A
Q100-102,104-106,111,123	TRANS, NPN, MMBT3904	TG-238
Q103,107,109,110,112	TRANS, N-MOSFET, VN0605T	TG-243
Q108	TRANS, PNP, MMBT3906L	TG-244
Q122	TRANS, P-CHAN, MOSFET, TP0610T	TG-259
R100,R169	RES, 200, 1%, 100MW, THICK FILM	R-418-200
R101,112,143,150,176,177,181,186,187,189	RES, 475, 1%, 100MW, THICK FILM	R-418-475
R102	RES, 6.04K, 1%, 100MW, THICK FILM	R-418-6.04K
R103,155,254,163,174,185,255	RES, 10K, 1%, 100MW, THICK FILM	R-418-10K
R105	RES, 4.99K, 1%, 100MW, THICK FILM	R-418-4.99K
R106,R162	RES, 16.9K, 1%, .125W, METAL FILM	R-391-16.9K
R107,R158,R191,R118	RES, 1K, 1%, 100MW, THICK FILM	R-418-1K
R109,110,115,120-122,126,127,129,119,227	RES, 10K, 1%, 100MW, THICK FILM	R-418-10K
R111,R165	RES, 4.02K,1%, 100MW, THICK FILM	R-418-4.02K

Table 4-1 (continued)
Models 2303 and 2303-PJ digital board parts list

Circuit designation	Description	Keithley part no.
R113,R156	RES, 24.3, 1%, 100MW, THICK FILM	R-418-24.3
R114	RES, 332K,1%, 100MW, THICK FILM	R-418-332K
R116,R167	RES, 2K, 1%, 100MW, THICK FILM	R-418-2K
R117,R168	RES, 2K, 1%, 125MW, METAL FILM	R-391-2K
R123,R170,R172	RES, 8.06K, 1%, .1W, THICK FILM	R-418-8.06K
R124,R125,R188	RES,1K, 5% 250MW, METAL FILM	R-376-1K
R128,R151,R232,R273	RES, 1K, 1%, 100MW, THICK FILM	R-418-1K
R130,R225,R243	RES, 4.75K, 1%, 100MW, THICK FILM	R-418-4.75K
R133	RES, 1.5K, 5%, 250MW, METAL FILM	R-376-1.5K
R137	RES, 66.5K, 1%, 100MW, THICK FILM	R-418-66.5K
R141	RES, 1M, 1%, 100MW, THICK FILM	R-418-1M
R144,R145,R146,R149	RES, 10K, .1%, .125W, THIN FILM	R-456-10K
R147,R148	RES, 20K, .1%, .125W, THIN FILM	R-456-20K
R153	RES, 49.9K, 1%, 100MW, THICK FILM	R-418-49.9K
R154	RES, 10M, 1%, 125MW, THICK FILM	R-418-10M
R164	RES, 1M, 1%, 100MW, THICK FILM	R-418-1M
R166	RES, 150K, 1%, 100MW, THICK FILM	R-418-150K
R171,R180,R192,R197	RES, 100, 1%, 100MW, THICK FILM	R-418-100
R175	RES, 10, 10%, 100MW, THICK FILM	R-418-10
R182	RES, 1K, 1%, 125MW, METAL FILM	R-391-1K
R183	RES NET	TF-245
R184	RES, 1.28M, .1%, 1/8W, METAL FILM	R-176-1.28M
R190,193-196,269	RES, 475, 1%, 100MW, THICK FILM	R-418-475
R198	RES, 499, 1%, 100MW, THICK FILM	R-418-499
R199	RES, 15k, 1%, 100MW, THICK FILM	R-418-15K
R221	RES, 866, 1%, 100MW, THICK FILM	R-418-866
R223,R231	RES, 10M, 1%, 125MW, THICK FILM	R-418-10M
R226,R142	RES, 10K, 1%, 100MW, THICK FILM	R-418-10K
R230,247,250,132,134,152,222,224,135	RES, 10K, 1%, 100MW, THICK FILM	R-418-10K
R235,R238	RES, 2K, 1%, 100MW, THICK FILM	R-418-2K
R236,R237	RES, 2.21K, 1%, 100MW, THICK FILM	R-418-2.21K
R239	RES, 6.04K, 1%, 125MW, THIN FILM	R-423-6.04K
R240,R108,R279	RES, 100K, 1%, 100MW, THICK FILM	R-418-100K
R241	RES, 3.01K, 1%, 125MW, METAL FILM	R-391-3.01K
R242,R252	RES, 100, 1%, 100MW, THICK FILM	R-418-100
R244	RES, 82.5, 1%, 100MW, THICK FILM	R-418-82.5

Table 4-1 (continued)
Models 2303 and 2303-PJ digital board parts list

Circuit designation	Description	Keithley part no.
R245	RES, 34K, 1%, 100MW, THICK FILM	R-418-34K
R246,R270,R272	RES, 475, 1%, 100MW, THICK FILM	R-418-475
R248	RES, 470, 5%, 125MW, METAL FILM	R-375-470
R249	RES, 5.11K, 1%, 100MW, THICK FILM	R-418-5.11K
R251	RES, 49.9K, 1%, 100MW, THICK FILM	R-418-49.9K
R253	RES, 6.04K, 1%, 100MW, THICK FILM	R-418-6.04K
R260	RES, 4.02K, 1%, 100MW, THICK FILM	R-418-4.02K
R263	RES, 20K, 1%, 100MW THICK FILM	R-418-20K
R264	RES, 24.9K, 1%, 100MW, THICK FILM	R-418-24.9K
R278	RES, 15k, 1%, 100MW, THICK FILM	R-418-15K
R280	RES, 249K, 1%, 100MW, THICK FILM	R-418-249K
R289	RES, 332, 1%, 100MW, THICK FILM	R-418-332
R290	RES, 909, 1%, 1W, THICK FILM	R-418-909
RT102	THERMISTER, PD=7MW/DEG C, 1500V, 613.74K	RT-8
RV100	METAL OXIDE VARISTOR	VR-7
RV102	VARISTOR	VR-14
S100	SWITCH, PUSHBUTTON (6 POLE)	SW-466
TP100-109,111,112	CONNECTOR	CS-985
U100	RS-232 LINE DRIVER/RECEIVER	IC-1129
U101,U128	IC, VOLT. COMPARATOR, LM311M	IC-776
U102	12-BIT VOLTAGE OUTPUT DAC	IC-1130
U103	IC, +5V VOLTAGE REGULATOR, LM2940CT	IC-576
U104,U115	HIGH SPEED PWM CONTROLLER	IC-1119
U106	IC, 8-CHAN ANA MULTIPLEXER, DG408DY	IC-844
U107	LOW NOISE OPAMP	IC-1127
U108	IC, 8 STAGE SHIFT/STORE, MC14094BD	IC-772
U109	HIGH PRECISION 10V REFERENCE	IC-1121
U110A	IC, DUAL SER INPUT VLTG OUTPUT, 12BITMDAC	IC-973
U111	IC, OP-AMP, AD705JR	IC-814
U113	IC +5V RS-232 TRANSCEIVER, MAX202	IC-952
U114,U149	IC, VOLT COMPARATOR LM393D	IC-775
U116	IC, OPTOCOUPLER, 2601	IC-239

Table 4-1 (continued)
Models 2303 and 2303-PJ digital board parts list

Circuit designation	Description	Keithley part no.
U117	IC, QUAD D FLIP FLOP W/CLK, RESET 74HC175	IC-923
U118	IC, NCHAN LAT DMOS QUADFET, SD5400CY	IC-893
U119,U125	IC, QUAD 2 IN NOR, 74HCT02	IC-809
U120	IC, QUAD 2-INPUT NAND, 74HC00M	IC-781
U121	SILICON-GATE CMOS	IC-1123
U122,U142,U133	IC, DUAL HIGH CMR/SPEED OPTO, HCPL-2631	IC-588
U123	PROGRAMMED ROM	2303-803A**
U124	LARGE SCALE IC	LSI-162-70
U127	IC, MOT MC68331CPV16	LSI-188
U129	INTEGRATED CIRCUIT, OPA177GS	IC-960
U130	DUAL DECADE RIPPLE COUNTER	IC-1131
U131	IC, OCTAL INTERFACE BUS, 75160	IC-646
U132	IC, DUAL BIPOLAR OP-AMP, LT1124CS8	IC-955
U134	PRECISION BIFET OPAMP	IC-1194
U135	IC, OP-AMP, NE5534D	IC-802
U136	PROGRAMMED ROM	2000-802**
U137	IC, GPIB ADAPTER, 9914A (PLCC)	LSI-123
U138	QUAD SPST ANALOG SWITCH	IC-1211
U140,U148,U139	IC, POS NAND GATES/INVERT, 74HCT14	IC-656
U141	IC, OCTAL INTER BUS TRANS, 75161	IC-647
U145	IC, SERIAL EPROM 24LC16B	LSI-153
U147	IC, DUAL D-TYPE F/F, 74HC74	IC-773
U154	CMOS ANALOG SWITCH	IC-1210
VR100,VR102	DIODE, ZENER, 6.2V, MMSZ6V2	DZ-97
VR101	DIODE, ZENER 6.44V, IN4577AGED	DZ-58
Y100	OSCILLATOR HIGH SPEED CMOS 12MHZ	CR-37
Y101	CRYSTAL, FSM327	CR-41

** Order present firmware revision level

Table 4-2
Models 2303 and 2303-PJ analog board parts list

Circuit designation	Description	Keithley part no.
C301,308,310,312,313,320,325,329,333,337	CAP, .1UF, 10%, 25V, CERAMIC	C-495-.1
C302,C489,C506	CAP, 1UF, 20%, 50V, TANTALUM	C-431-1
C303,C309	CAP, 7.5P, 10%, 100V, CERAMIC	C-452-7.5P
C304,488,307,315,317,321,328,338,339,346	CAP, .1UF, 20%, 50V, CERAMIC	C-418-.1
C314,335,336,371,372,377,378	CAP, 47UF, 20%, 100V, ALUM ELEC	C-521-47
C319,C498,C306,C330	CAP, 4.7PF, 5%, 50V, MONO-CERAMIC	C-452-4.7P
C322,331,359-361,374,343,434,508	CAP, 22UF, 20%, 25V, TANTALUM	C-440-22
C323,C416,C422	CAP, 22U, 20%, 25V, TANTALUM	C-535-22
C326,C404,C487	CAP, 1UF, 20%, 35V, TANTALUM	C-494-1
C334	CAP, 100UF, 20%, 25V, ALUM ELEC	C-413-100
C347,C478	CAP, 470U, 20%, 25V, ALUM ELEC	C-478-470
C348,351,366,417,486	CAP, .1UF, 10%, 25V, CERAMIC	C-495-.1
C352,354,355,358,373,379,382,384,515-519	CAP, .1UF, 20%, 50V, CERAMIC	C-418-.1
C353,C357,C367	CAP, 1000P, 10%, 100V, CERAMIC	C-451-1000P
C356,C499,C500	CAP, 100PF, 5%, 100V, CERAMIC	C-465-100P
C362,C509	CAP, 220PF, 10%, 100V, CERAMIC	C-451-220P
C363,C480,C481	CAP, 3300P, 10%, 500V, CERAMIC	C-497-3300P
C365	CAP, 2200P, 1%, 50V, CERAMIC	C-532-2200P
C368,C369	CAP, 100UF, 20%, 16V, TANTALUM	C-504-100
C370,C305	CAP, 2.2U, 10%, 50V, TANTALUM	C-563-2.2
C376	CAP, .022UF, 10%, 50V, CERAMIC	C-491-.022
C390,407,414,415,423,424,494,495,435-437	CAP, .1UF, 20%, 50V, CERAMIC	C-418-.1
C392,C393,C350,C491	CAP, .01, 5%, 50V, NPO	C-514-.01
C394,C396	CAP, 1500P, 20%, 700V	C-560-1500P
C395	CAP, 10U, 20%, 35V, ALUMINUM	C-562-10
C402,C397	CAP, 47PF, 10%, 100V, CERAMIC	C-451-47P
C405,C421	CAP, .033U, 10%, 50V, CERAMIC	C-491-.033
C406,C410	CAPACITOR	C-570-470
C426-429,344,345,479,482,483	CAPACITOR SMT	C-568-2200P
C438-C477,C505	CAP, 1U, 10%, 50V, CERAMIC	C-564-1
C490	CAP, 100P, 10%, 100V CERAMIC	C-451-100P
C492,C493	CAP, 390P, 10%, 100V, CERAMIC	C-451-390P
C497,C514	CAP, 150PF, 5%, 100V,CERAMIC	C-465-150P
C501,502,503,419,504,507,510,511,420	CAP, .1UF, 20%, 50V, CERAMIC	C-418-.1
C512,C513,C380,C385,C318,C364	CAP, .1UF, 20%, 50V, CERAMIC	C-418-.1
CR302,CR322,CR330,CR332,CR318	DIODE, SWITCHING, MMSD914T19	RF-112

Table 4-2 (continued)
Models 2303 and 2303-PJ analog board parts list

Circuit designation	Description	Keithley part no.
CR303-306,308,309,311,312,319,327-329	DIODE, MBRS140T3	RF-110
CR307,CR310	SCHOTTKY BARRIER DIODE	RF-108
CR313	ULTRA FAST BRIDGE RECTIFIER	RF-123
CR314	DIODE, BRIDGE PE05	RF-48
CR315	DIODE, SILICON, 53A4	RF-47
CR323,CR324,CR325,CR326	SCHOTTKY DIODE	RF-121
CR331	DIODE, BARRIER, MBR745	RF-65
HS301-309	HEAT SINK	HS-55
HS310	HEAT SINK	HS-41
J1007	CONN, HEADER STRAIGHT SOLDER PIN	CS-368-26
J1009	CONN, HEADER STRAIGHT SOLDER PIN	CS-368-16
J1010	CONN, MALE, 5-PIN (MOLEX 42491)	CS-784-5
J1011	CONNECTOR, MODULES	CS-834
L301,L302,L304,L305,L306	CHOKE, EMI	CH-57
L303,L311	LINE FILTER	CH-85-10
L308,L309	INDUCTOR	CH-89-1
L310	CHOKE SMT	CH-66-100
Q301	TRANS, CURRENT REGULATOR	TG-341
Q304	TRANS, N CHANNEL FET, 2N4392	TG-128-1
Q305,Q306,Q307,Q308	TRANS, N CHANNEL JFET, SNJ132199	TG-294
Q310,Q311	TRANS, N CHANNEL FET, IRF530	TG-184
Q312	TRANS, NPN, MMBT3904	TG-238
Q313,315,314,332	HEXFET POWER MOSFET	TG-354
Q323-326	RECTIFIER	TG-337
Q327	TRANS, N-MOSFET, VN0605T	TG-243
Q333	P CHANNEL MOSFET	TG-363
Q334,Q335,Q330,Q331	HEXFET POWER MOSFET	TG-358
Q338,Q341	PNP SILICON TRANSISTOR	TG-310
Q339,Q340	NPN SILICON TRANSISTOR	TG-309
Q342	TRANS, PNP, MMBT3906L	TG-244
Q343	TRANS, N-CHAN JFET, SST4393	TG-263
R301,R302,R334,R336,R351	RES, 10K, .1%, .125W, THIN FILM	R-456-10K
R304	RES, 24.9K, 1%, 100MW, THICK FILM	R-418-24.9K
R306,R308,R313,R442,R490,R438	RES, 4.99K, 1%, 100MW, THICK FILM	R-418-4.99K
R307	THICK FILM	TF-262

Table 4-2 (continued)*Models 2303 and 2303-PJ analog board parts list*

Circuit designation	Description	Keithley part no.
R315,372,314,492,415,441,458-460	RES, 10K, 1%, 100MW, THICK FILM	R-418-10K
R320,R444	RES, 100K, 1%, 100MW, THICK FILM	R-418-100K
R321,R503	RES, 1M, 1%, 100MW, THICK FILM	R-418-1M
R322,R489	RES, 8.06K, 1%, .1W, THICK FILM	R-418-8.06K
R325	RES, 10, 10%, 100MW, THICK FILM	R-418-10
R326	RES, 14K, 1%, 125MW, METAL FILM	R-391-14K
R329-332,357,358,360,361,378,379,390,391	RES, 10K, 5%, 250MW, METAL FILM	R-376-10K
R333,R335,R349,R355	RES, 20K, 5%, 250MW, METAL FILM	R-376-20K
R337,R343,R344,R456,R457,R476,R477, R499	RES, 1K, 1%, 100MW, THICK FILM	R-418-1K
R340,R341	RES, 1K, 5% 250MW, METAL FILM	R-376-1K
R342	RES, 24.3, 1%, 100MW, THICK FILM	R-418-24.3
R345,R346,R347,R348	RES, 560, 5%, 250MW, METAL FILM	R-376-560
R350,368,426-428,435,328,339	RES, 10,5%, 125MW, METAL FILM	R-375-10
R352,R478,R491	RES, 20K, 1%, 100MW, THICK FILM	R-418-20K
R353,354,461,473,495,496	RES, 475, 1%, 100MW, THICK FILM	R-418-475
R363,R370	RES, 8,98K, .1%, .125W, THIN FILM	R-456-8.98K
R364,R369	RES, 1K, .1%, .125W, THIN FILM	R-456-1K
R373,R374,R387,R392	RES, 20K, 1%, 125MW, METAL FILM	R-391-20K
R375,R377	RES, 1K, 5%, 1W 200V, THICK FILM	R-437-1K
R376	RES, 100, .1%, 1/2W, METAL FILM	R-169-100*
R376	RES, 1, 1%, 1W, METAL FILM	R-487-1**
R383,R385,R386,R388	RES, 49.9K, 1%, 125MW, METAL FILM	R-391-2.87K
R384	RES, 4.02K, 1%, 100MW, THICK FILM	R-418-4.02K
R393,R394	RES, .02, 1.5W, 1%	R-468-.02
R397	RES, 357, 1%, 100MW, THICK FILM	R-418-357
R399,R400,R488	RES, .0499, 1%, 100MW, THICK FILM	R-418-.0499
R401	RES, 301, 1%, 100MW, THICK FILM	R-418-301
R411,413,417,419,474,483	RES, 100, 1%, 100MW, THICK FILM	R-418-100
R421,R422,R480	RES, 200K, 1%, 125MW, METAL FILM	R-391-200K
R429,433,434,436,356,371	RES, 7.5, 5%, .5W, THICK FILM	R-469-7.5
R432	RES, 3.01K, 1%, 100MW, THICK FILM	R-418-3.01K
R455	RES, .1, 1%, 3W	R-475-.1

* Model 2303 only.

** Model 2303-PJ only.

Table 4-2 (continued)
Models 2303 and 2303-PJ analog board parts list

Circuit designation	Description	Keithley part no.
R462-464,467,468	RES, 10K, 1%, 100MW, THICK FILM	R-418-10K
R465,R494	RES, 11K, 1%, 100MW, THICK FILM	R-418-11K
R469	RES, 49.9K, 1%, 100MW, THICK FILM	R-418-49.9K
R470,R497	RES, .2, 1%, 30W	R-463-.2
R471	RES, .1, 1%, 30W	R-463-.1
R475,R484	RES, 47.5, 1%, 100MW THICK FILM	R-418-47.5
R479	RES, 20K, .1%, .125W THIN FILM	R-456-20K
R481,R482	RES, 4.99K, .1%, .125W THIN FILM	R-456-4.99K
R493	RES, 45.3K, 1%, 100MW THICK FILM	R-418-45.3K
R498	RES, .2, 1%, 1W (2512)	R-441-.2
R500,R501,R502,R507	RES, 18.5%, 1W 200V THICK FILM	R-437-18
T301	TRANSFORMER	TR-314A
TP301-310,311,314,316-318	CONNECTOR	CS-985
U301,U321	DUAL FET OPAMP	IC-1128
U302,U304,U308,U316,U335	PRECISION BIFET OPAMP	IC-1194
U303	IC, QUAD 2 IN AND, 74HCT08	IC-837
U305,U307	IC, VOLTAGE REGULATOR, LM340-12	IC-60
U306,U311,U322,U330	IC, VOLT COMPARATOR, LM393D	IC-775
U310	MICROPOWER VOLTAGE REGULATOR	IC-1152
U312	LOW POWER INSTRUMENT AMP	IC-1124
U313	IC, NEG VOLTAGE REG -15V, 500MA, 79M15	IC-195
U314	HIGH SPEED PWN CONTROLLER	IC-1120
U315	IC,+5V VOLTAGE REGULA-TOR,LM2940CT	IC-576
U317	DUAL \pm 15V ZERO DRIFT OPAMP	IC-1126
U320	IC,POS VOLTAGE REG +15V ,500MA, 78M15	IC-194
U324	IC, CMOS ANAL SWITCH, DG444DY,	IC-866
U327	80V 2.5A FULL BRIDGE FET DRIVER	IC-1139
U329	IC, VOLT. COMPARATOR, LM311M	IC-776
U333	POWER OUTPUT STAGE AUTO BIAS	IC-1159
U334,U336	IC, DUAL OP-AMP, LF353M	IC-842
VR303,VR310	DIODE, ZENER, 6.8V, MMSZ5235BT1	DZ-100
VR305,VR312	DIODE, ZENER MM524694 TI	DZ-113
VR306,VR307	DIODE, ZENER 6.0V, BZX84B6V2	DZ-87
VR311	DIODE, ZENER	DZ-121

Table 4-3
Models 2303 and 2303-PJ display board parts

Circuit designation	Description	Keithley part no.
C601,C602	CAP, 33PF, 10%, 100V, CERAMIC	C-451-33P
C603	CAP, .1UF, 10%, 25V, CERAMIC	C-495-.1
C609	CAP, .1UF, 10%, 25V, CERAMIC	C-495-.1
C611	CAP, 10UF,20%, 25V, TANTALUM	C-440-10
C613	CAP, 1U, 10%, 50V, CERAMIC	C-564-1
J1008	CONN, HEADER STRAIGHT SOLDER PIN	CS-368-10
J1013	CONNECTOR, RIGHT ANGLE	CS-362
J1014	CONN, BERG	CS-339
L601,L602,L603,L604	FERRITE CHIP 600 OHM BLM32A07	CH-62
R601	RES, 10M, 5%, 125MW, METAL FILM	R-375-10M
R602-605,611,614,616,618,620,623,625	RES, 10K, 1%, 100MW, THICK FILM	R-418-10K
R606,608,610,613,615,617,619,621	RES, 15k, 1%, 100MW, THICK FILM	R-418-15K
R607,R609	RES, 20, 1%, 100MW, THICK FILM	R-418-20
R612	RES, 4.75K, 1%, 100MW, THICK FILM	R-418-4.75K
R622	RES, 15k, 1%, 100MW, THICK FILM	R-418-15K
R624	RES, 604, 1%, 100MW, THICK FILM	R-418-604
RV601,RV602	300W TRANSIENT VOLTAGE SUPPRES- SOR	VR-13
S0601	SOCKET	SO-143-44
U601	UNDERVOLTAGE SENSE CIRCUIT	IC-1067
U603	PROGRAMMED ROM	2304-800**
Y601	CRYSTAL, 4MHZ	CR-36-4M

**Order present firmware revision level.

Table 4-4
Models 2303 and 2303-PJ mechanical parts list

Qty.	Description	Keithley part no.
1	BEZEL, REAR	428-303D
1	CHASSIS	2304-301
1	COVER	2000-307C
1	FAN	FN-34-1
2	FOOT	428-319A
2	FOOT, EXTRUDED	FE-22A
2	FOOT, RUBBER	FE-6
1	FUSE, 2A, 250V, TIME LAG (5X20MM) F100	FU-81
1	HANDLE	428-329F
1	IEEE CONNECTOR, HARDWARE KIT	CS-713
1	LINE CORD	CO-7
1	LINE FILTER	LF-11
1	MEMBRANE SWITCH FRONT PANEL	2303-313A
1	MOUNTING EAR, LEFT	428-338B
1	MOUNTING EAR, RIGHT	428-328E
1	POWER ROD	704-313A
1	REAR PANEL	2304-303

Model 2303B parts lists

Table 4-5

Model 2303B digital board lists

Circuit designation	Description	Keithley part no.
C100,111,117,122,124,128,151-153,213	CAP, .1UF, 20%, 50V, CERAMIC	C-418-.1
C101,C102,C105,C115	CAP, .1UF, 10%, 25V, CERAMIC	C-495-.1
C106,C150,C265	CAP, 1000PF, 10%, 50V, MONO CERAMIC	C-452-1000P
C107,C108,C129,C133	CAP, 22U 20%, 25V, TANTALUM	C-535-22
C109,C184	CAP, 1000pF, 20%, 50V, CERAMIC	C-418-1000P
C110,C112,C116,C120,C130,C141,C161, C162	CAP, .01UF, 10%, 50V, CERAMIC	C-491-.01
C113	CAP, 68PF, 10%, 100V, CERAMIC	C-451-68P
C114,C145	CAP, 22PF, 10%, 100V, CERAMIC	C-451-22P
C118,C138	CAP, 2200P, 1%, 50V, CERAMIC	C-532-2200P
C119,C148,C156	CAP, 100PF, 5%, 100V, CERAMIC	C-465-100P
C123,134,269,139,147	CAP, 10UF, 20%, 25V, TANTALUM	C-440-10
C125,126,274,149,154,155,196,275	CAP, .1UF, 10%, 25V, CERAMIC	C-495-.1
C127,C146	CAP, 470P, 10%, 100V, CERAMIC	C-451-470P
C135,C266	CAP, 2.2U, 10%, 50V TANTALUM	C-563-2.2
C136,157,165,189,193,282,204,121,103	CAP, .1UF, 20%, 50V, CERAMIC	C-418-.1
C143	CAP, 270PF, 5%, 100V, CERAMIC	C-465-270P
C158	CAP, .01uF, 20%, 50V, CERAMIC	C-418-.01
C159	CAP, .022UF, 10%, 50V, CERAMIC	C-491-.022
C160,142,166,197,264,276	CAP, 22UF, 20%, 25V, TANTALUM	C-440-22
C163,C190,C195	CAP, .01UF, 10%, 50V, CERAMIC	C-491-.01
C167	CAP, 4700PF, 20%, 50V, CERAMIC	C-418-4700P
C171,C188	CAP, 47P, 5%, 100V, CERAMIC	C-465-47P
C173,C183	CAP, 2200P, 10%, 100V, CERAMIC	C-430-2200P
C179,C185,C212,C214	CAP, 1000P, 10%, 100V, CERAMIC	C-451-1000P
C181	CAP, 220UF, \pm 20%, 50V, ALUM ELEC	C-507-220
C191,C192,C168	CAP, 15P, 1%, 100V, CERAMIC	C-512-15P
C194	CAP, .1UF, 10%, 25V, CERAMIC	C-495-.1
C215-222,225-230,238,241,244,246-248	CAP, .1UF, 20%, 50V, CERAMIC	C-418-.1
C223,C224,C273	CAP, .47U, 20%, 25V	C-520-.47
C233,C234,C235	CAP, .1UF, 20%, 50V, CERAMIC	C-418-.1
C236,C239,C277	CAP, 1UF, 20%, 35V, TANTALUM	C-494-1
C237,C240	CAP, 22PF, 10%, 100V, CERAMIC	C-451-22P
C245,C249,C258,C164	CAP, 47P, 5%, 100V, CERAMIC	C-465-47P

Table 4-5 (continued)
 Model 2303B digital board lists

Circuit designation	Description	Keithley part no.
C250,C251	CAP, .01UF, 10%, 50V, CERAMIC	C-491-.01
C252,253,255-257,259-263,271,169,270	CAP, .1UF, 20%, 50V, CERAMIC	C-418-.1
C254	CAP,100PF, 5%, 100V, CERAMIC	C-465-100P
C280,281,172,174-177,180,182,186,187	CAP, .1UF, 10%, 25V, CERAMIC	C-495-.1
C285	CAP, .15UF, 20%, 50V, CERAMIC	C-418-.15
C286	CAP, .047U, 10%, 50V, CERAMIC	C-491-.047
C288,C289	CAP, .1UF, 20%, 50V, CERAMIC	C-418-.1
C293	CAP, .01UF, 20%, 50V, CERAMIC	C-418-.01
C294,C284	CAP, .47, 10% 16V CERAMIC	C-565-.47
CR100,CR101,CR110,CR111	DIODE, SWITCHING, MMSD914T19	RF-112
CR104	DIODE, DUAL HSM-2822T31	RF-95
J1002	CONN, MOLEX, 3-PIN	CS-772-3
J1003	CONN, RIGHT ANGLE, 24PIN	CS-507
J1005	SHIELDED RT. ANGLE PHONE JACK	CS-981
J1006, J1013,J1015	LATCHING HEADER, FRICTON, SGL ROW	CS-724-3
L101	EMI SUPPRESSION INDUCTOR	CH-84
L103,L104,L105,L109	FERRITE CHIP 600 OHM BLM32A07	CH-62
L106,L107,L108	FERRITE CHIP 600 OHM BLM32A07	CH-62
P1007	CABLE ASSEMBLY, 26 CONDUCTOR	CA-27-6
P1008	CABLE ASSEMBLY WITH GROUND PLANE	CA-152-2B
P1009	CABLE ASSEMBLY	CA-62-4B
P1010	CABLE ASSEMBLY	CA-171-1A
PS100	POWER SUPPLY	PS-64A
Q100-102,104-106,111,123	TRANS, NPN, MMBT3904	TG-238
Q103,107,109,110,112	TRANS, N-MOSFET, VN0605T	TG-243
Q108	TRANS, PNP, MMBT3906L	TG-244
Q122	TRANS, P-CHAN, MOSFET, TP0610T	TG-259
R100,R169	RES, 200, 1%, 100MW, THICK FILM	R-418-200
R101,112,143,150,176,177,181,186,187,189	RES, 475, 1%, 100MW, THICK FILM	R-418-475
R102	RES, 6.04K, 1%, 100MW, THICK FILM	R-418-6.04K
R103,155,254,163,174,185,255	RES, 10K, 1%, 100MW, THICK FILM	R-418-10K
R105	RES, 4.99K, 1%, 100MW, THICK FILM	R-418-4.99K
R106,R162	RES, 16.9K, 1%, .125W, METAL FILM	R-391-16.9K
R107,R158,R191,R118	RES, 1K, 1%, 100MW, THICK FILM	R-418-1K
R109,110,115,120-122,126,127,129,119,227	RES, 10K, 1%, 100MW, THICK FILM	R-418-10K

Table 4-5 (continued)

Model 2303B digital board lists

Circuit designation	Description	Keithley part no.
R111,R165	RES, 4.02K, 1%, 100MW, THICK FILM	R-418-4.02K
R113,R156	RES, 24.3, 1%, 100MW, THICK FILM	R-418-24.3
R114	RES, 332K,1%, 100MW, THICK FILM	R-418-332K
R116,R167	RES, 2K, 1%, 100MW, THICK FILM	R-418-2K
R117,R168	RES, 2K, 1%, 125MW, METAL FILM	R-391-2K
R123,R170,R172	RES, 8.06K, 1%, .1W, THICK FILM	R-418-8.06K
R124,R125,R188	RES, 1K, 5% 250MW, METAL FILM	R-376-1K
R128,R151,R232,R273	RES, 1K, 1%, 100MW, THICK FILM	R-418-1K
R130,R225,R243	RES, 4.75K, 1%, 100MW, THICK FILM	R-418-4.75K
R133	RES, 1.5K, 5%, 250MW, METAL FILM	R-376-1.5K
R137	RES, 66.5K, 1%, 100MW, THICK FILM	R-418-66.5K
R141	RES, 1M, 1%, 100MW, THICK FILM	R-418-1M
R144,R145,R146,R149	RES, 10K, .1%, .125W, THIN FILM	R-456-10K
R147,R148	RES, 20K, .1%, .125W, THIN FILM	R-456-20K
R153	RES, 49.9K, 1%, 100MW, THICK FILM	R-418-49.9K
R154	RES, 10M, 1%, 125MW, THICK FILM	R-418-10M
R164	RES, 1M, 1%, 100MW, THICK FILM	R-418-1M
R166	RES, 150K, 1%, 100MW, THICK FILM	R-418-150K
R171,R180,R192,R197	RES, 100, 1%, 100MW, THICK FILM	R-418-100
R175	RES, 10, 10%, 100MW, THICK FILM	R-418-10
R182	RES, 1K, 1%, 125MW, METAL FILM	R-391-1K
R183	RES NET	TF-245
R184	RES, 1.28M, .1%, 1/8W METAL FILM	R-176-1.28M
R190,193-196,269	RES, 475, 1%, 100MW, THICK FILM	R-418-475
R198	RES, 499, 1%, 100MW THICK FILM	R-418-499
R199	RES, 15k, 1%, 100MW, THICK FILM	R-418-15K
R221	RES, 866, 1%, 100MW THICK FILM	R-418-866
R223,R231	RES, 10M, 1%, 125MW, THICK FILM	R-418-10M
R226,R142	RES, 10K, 1%, 100MW, THICK FILM	R-418-10K
R230,247,250,132,134,152,222,224,135	RES, 10K, 1%, 100MW, THICK FILM	R-418-10K
R235,R238	RES, 2K, 1%, 100MW, THICK FILM	R-418-2K
R236,R237	RES, 2.21K, 1%, 100MW, THICK FILM	R-418-2.21K
R239	RES, 6.04K, 1%, 125MW, THIN FILM	R-423-6.04K
R240,R108,R279	RES, 100K, 1%, 100MW, THICK FILM	R-418-100K
R241	RES, 3.01K, 1%, 125MW, METAL FILM	R-391-3.01K
R242,R252	RES, 100, 1%, 100MW, THICK FILM	R-418-100

Table 4-5 (continued)
 Model 2303B digital board lists

Circuit designation	Description	Keithley part no.
R244	RES, 82.5, 1%, 100MW, THICK FILM	R-418-82.5
R245	RES, 34K, 1%, 100MW, THICK FILM	R-418-34K
R246,R270,R272	RES, 475, 1%, 100MW, THICK FILM	R-418-475
R248	RES, 470,5%, 125MW, METAL FILM	R-375-470
R249	RES, 5.11K, 1%, 100MW, THICK FILM	R-418-5.11K
R251	RES, 49.9K, 1%, 100MW, THICK FILM	R-418-49.9K
R253	RES, 6.04K, 1%, 100MW, THICK FILM	R-418-6.04K
R260	RES,4.02K,1%,100MW, THICK FILM	R-418-4.02K
R263	RES, 20K, 1%, 100MW THICK FILM	R-418-20K
R264	RES, 24.9K, 1%, 100MW, THICK FILM	R-418-24.9K
R278	RES, 15k, 1%, 100MW, THICK FILM	R-418-15K
R280	RES, 249K, 1%, 100MW, THICK FILM	R-418-249K
R289	RES, 332, 1%, 100MW, THICK FILM	R-418-332
R290	RES, 909, 1%, 1W, THICK FILM	R-418-909
RT102	THERMISTER, PD=7MW/DEG C, 1500V, 613.74K	RT-8
RV100	METAL OXIDE VARISTOR	VR-7
RV102	VARISTOR	VR-14
S100	SWITCH, PUSHBUTTON (6 POLE)	SW-466
SO100 FOR U123	SOCKET PLCC-032-T-A	SO-143-32
TP100-109,111,112	CONNECTOR	CS-985
U100	RS-232 LINE DRIVER/RECEIVER	IC-1129
U101,U128	IC, VOLT. COMPARATOR,LM311M	IC-776
U102	12-BIT VOLTAGE OUTPUT DAC	IC-1130
U103	IC, +5V VOLTAGE REGULATOR, LM2940CT	IC-576
U104,U115	HIGH SPEED PWM CONTROLLER	IC-1119
U106	IC, 8-CHAN ANA MULTIPLEXER, DG408DY	IC-844
U107	LOW NOISE OPAMP	IC-1127
U108	IC, 8 STAGE SHIFT/STORE, MC14094BD	IC-772
U109	HIGH PRECISION 10V REFERENCE	IC-1121
U110A	IC, DUAL SER INPUT VLTG OUTPUT, 12BITMDAC	IC-973
U111	IC, OP-AMP, AD705JR	IC-814
U113	IC, +5V RS-232 TRANSCEIVER, MAX202	IC-952
U114,U149	IC, VOLT COMPARATOR LM393D	IC-775

Table 4-5 (continued)

Model 2303B digital board lists

Circuit designation	Description	Keithley part no.
U116	IC, OPTOCOUPLER, 2601	IC-239
U117	IC, QUAD D FLIP FLOP W/CLK, RESET 74HC175	IC-923
U118	IC, NCHAN LAT DMOS QUADFET, SD5400CY	IC-893
U119,U125	IC, QUAD 2 IN NOR, 74HCT02	IC-809
U120	IC, QUAD 2-INPUT NAND, 74HC00M	IC-781
U121	SILICON-GATE CMOS	IC-1123
U122,U142,U133	IC, DUAL HIGH CMR/SPEED OPTO, HCPL-2631	IC-588
U123	PROGRAMMED ROM	2303-803A**
U124	LARGE SCALE IC	LSI-162-70
U127	IC, MOT MC68331CPV16	LSI-188
U129	INTEGRATED CIRCUIT, OPA177GS	IC-960
U130	DUAL DECADE RIPPLE COUNTER	IC-1131
U131	IC, OCTAL INTERFACE BUS, 75160	IC-646
U132	IC, DUAL BIPOLAR OP-AMP, LT1124CS8	IC-955
U134	PRECISION BIFET OPAMP	IC-1194
U135	IC, OP-AMP, NE5534D	IC-802
U136	PROGRAMMED ROM	2000-802**
U137	IC, GPIB ADAPTER, 9914A	LSI-123
U138	QUAD SPST ANALOG SWITCH	IC-1211
U140,U148,U139	IC, POS NAND GATES/INVERT, 74HCT14	IC-656
U141	IC, OCTAL INTER BUS TRANS, 75161	IC-647
U145	IC, SERIAL EPROM 24LC16B	LSI-153
U147	IC, DUAL D-TYPE F/F, 74HC74	IC-773
U154	CMOS ANALOG SWITCH	IC-1210
VR100,VR102	DIODE, ZENER, 6.2V MMSZ6V2	DZ-97
VR101	DIODE, ZENER 6.44V, IN4577AGED	DZ-58
Y100	OSCILLATOR HIGH SPEED CMOS 12MHZ	CR-37
Y101	CRYSTAL, FSM327	CR-41

** Order present firmware revision level.

Table 4-6
Model 2303B analog board parts list

Circuit designation	Description	Keithley part no.
C301,308,310,312,313,320,325,329,333,337	CAP, .1UF, 10%, 25V, CERAMIC	C-495-.1
C302,C489,C506	CAP, 1UF, 20%, 50V, TANTALUM	C-431-1
C303,C309	CAP, 7.5P, 10%, 100V, CERAMIC	C-452-7.5P
C304,488,307,315,317,321,328,338,339,346	CAP, .1UF, 20%, 50V, CERAMIC	C-418-.1
C314,335,336,371,372,377,378	CAP, 47UF, 20%, 100V, ALUM ELEC	C-521-47
C319,C498,C306,C330	CAP, 4.7PF, 5%, 50V, MONO-CERAMIC	C-452-4.7P
C322,331,359-361,374,343,434,508	CAP, 22UF, 20%, 25V, TANTALUM	C-440-22
C323,C416,C422	CAP, 22U, 20%, 25V, TANTALUM	C-535-22
C326,C404,C487	CAP, 1UF, 20%, 35V, TANTALUM	C-494-1
C334	CAP, 100UF, 20%, 25V, ALUM ELEC	C-413-100
C347,C478	CAP, 470U, 20%, 25V, ALUM ELEC	C-478-470
C348,351,366,417,486	CAP, .1UF, 10%, 25V, CERAMIC	C-495-.1
C352,354,355,358,373,379,382,384,515-519	CAP, .1UF, 20%, 50V, CERAMIC	C-418-.1
C353,C357,C367	CAP, 1000P, 10%, 100V, CERAMIC	C-451-1000P
C356,C499,C500	CAP, 100PF, 5%, 100V, CERAMIC	C-465-100P
C362,C509	CAP, 220PF, 10%, 100V, CERAMIC	C-451-220P
C363,C480,C481	CAP, 3300P, 10%, 500V, CERAMIC	C-497-3300P
C365	CAP, 2200P, 1%, 50V, CERAMIC	C-532-2200P
C368,C369	CAP, 100UF, 20%, 16V, TANTALUM	C-504-100
C370,C305	CAP, 2.2U, 10%, 50V, TANTALUM	C-563-2.2
C376	CAP, .022UF, 10%, 50V, CERAMIC	C-491-.022
C390,407,414,415,423,424,494,495,435-437	CAP, .1UF, 20%, 50V, CERAMIC	C-418-.1
C392,C393,C350,C491	CAP, .01, 5%, 50V, NPO	C-514-.01
C394,C396	CAP, 1500P, 20%, 700V	C-560-1500P
C395	CAP, 10U, 20%, 35V, ALUMINUM	C-562-10
C402,C397	CAP, 47PF, 10%, 100V, CERAMIC	C-451-47P
C405,C421	CAP, .033U, 10%, 50V, CERAMIC	C-491-.033
C406,C410	CAPACITOR	C-570-470
C426-429,344,345,479,482,483	CAPACITOR	C-568-2200P
C438-C477,C505	CAP, 1U, 10%, 50V, CERAMIC	C-564-1
C490	CAP, 100P, 10%, 100V, CERAMIC	C-451-100P
C492,C493	CAP, 390P, 10%, 100V, CERAMIC	C-451-390P
C497,C514	CAP, 150PF, 5%, 100V, CERAMIC	C-465-150P
C501,502,503,419,504,507,510,511,420	CAP, .1UF, 20%, 50V, CERAMIC	C-418-.1
C512,C513,C380,C385,C318,C364	CAP, .1UF, 20%, 50V, CERAMIC	C-418-.1
CR302,CR322,CR330,CR332,CR318	DIODE, SWITCHING, MMSD914T19	RF-112

Table 4-6 (continued)

Model 2303B analog board parts list

Circuit designation	Description	Keithley part no.
CR303-306,308,309,311,312,319,327-329	DIODE, MBRS140T3	RF-110
CR307,CR310	SCHOTTKY BARRIER DIODE	RF-108
CR313	ULTRA FAST BRIDGE RECTIFIER	RF-123
CR314	DIODE, BRIDGE PE05	RF-48
CR315	DIODE, SILICON, 53A4	RF-47
CR323,CR324,CR325,CR326	SCHOTTKY DIODE	RF-121
CR331	DIODE, BARRIER, MBR745	RF-65
J1007	CONN, HEADER STRAIGHT SOLDER PIN	CS-368-26
J1009	CONN, HEADER STRAIGHT SOLDER PIN	CS-368-16
J1010	CONN, MALE, 5-PIN (MOLEX 42491)	CS-784-5
J1011	CONNECTOR, MODULES	CS-834
L301,L302,L304,L305,L306	CHOKE, EMI	CH-57
L303,L311	LINE FILTER	CH-85-10
L308,L309	INDUCTOR	CH-89-1
L310	CHOKE	CH-66-100
Q301	TRANS, CURRENT REGULATOR	TG-341
Q304	TRANS, N CHANNEL FET, 2N4392	TG-128-1
Q305,Q306,Q307,Q308	TRANS, N CHANNEL JFET, SNJ132199	TG-294
Q310,Q311	TRANS, N CHANNEL FET, IRF530	TG-184
Q312	TRANS, NPN, MMBT3904	TG-238
Q313,315,314,332	HEXFET POWER MOSFET	TG-354
Q323-326	RECTIFIER	TG-337
Q327	TRANS, N-MOSFET, VN0605T	TG-243
Q333	P CHANNEL MOSFET	TG-363
Q334,Q335,Q330,Q331	HEXFET POWER MOSFET	TG-358
Q338,Q341	PNP SILICON TRANSISTOR	TG-310
Q339,Q340	NPN SILICON TRANSISTOR	TG-309
Q342	TRANS, PNP, MMBT3906L	TG-244
Q343	TRANS, N-CHAN JFET, SST4393	TG-263
R301,R302,R334,R336,R351	RES, 10K, .1%, .125W, THIN FILM	R-456-10K
R304	RES, 24.9K, 1%, 100MW, THICK FILM	R-418-24.9K
R306,R308,R313,R442,R490,R438	RES, 4.99K, 1%, 100MW THICK FILM	R-418-4.99K
R307	THICK FILM	TF-262
R315,372,314,492,415,441,458-460	RES, 10K, 1%, 100MW, THICK FILM	R-418-10K
R320,R444	RES, 100K, 1%, 100MW, THICK FILM	R-418-100K

Table 4-6 (continued)
 Model 2303B analog board parts list

Circuit designation	Description	Keithley part no.
R321,R503	RES, 1M, 1%, 100MW, THICK FILM	R-418-1M
R322,R489	RES, 8.06K, 1%, .1W, THICK FILM	R-418-8.06K
R325	RES, 10, 10%, 100MW, THICK FILM	R-418-10
R326	RES, 14K, 1%, 125MW, METAL FILM	R-391-14K
R329-332,357,358,360,361,378,379,390,391	RES, 10K, 5%, 250MW, METAL FILM	R-376-10K
R333,R335,R349,R355	RES, 20K, 5%, 250MW, METAL FILM	R-376-20K
R337,R343,R344,R456,R457,R476,R477, 23 R499	RES, 1K, 1%, 100MW, THICK FILM	R-418-1K
R340,R341	RES,1K, 5% 250MW, METAL FILM	R-376-1K
R342	RES, 24.3, 1%, 100MW, THICK FILM	R-418-24.3
R345,R346,R347,R348	RES, 560, 5%, 250MW, METAL FILM	R-376-560
R350,368,426-428,435,328,339	RES, 10,5%, 125MW, METAL FILM	R-375-10
R352,R478,R491	RES, 20K, 1%, 100MW THICK FILM	R-418-20K
R353,354,461,473,495,496	RES, 475, 1%, 100MW, THICK FILM	R-418-475
R363,R370	RES, 8,98K, .1%, .125W, THIN FILM	R-456-8.98K
R364,R369	RES, 1K, .1%, .125W, THIN FILM	R-456-1K
R373,R374,R387,R392	RES, 20K,1%,125MW, METAL FILM	R-391-20K
R375,R377	RES, 1K, 5%, 1W 200V THICK FILM	R-437-1K
R376	RES, 100, .1%, 1/2W, METAL FILM	R-169-100
R383,R385,R386,R388	RES, 49.9K, 1%, 125MW, METAL FILM	R-391-2.87K
R384	RES, 4.02K, 1%, 100MW, THICK FILM	R-418-4.02K
R393,R394	RES, .02, 1.5W, 1%	R-468-.02
R397	RES, 357, 1%, 100MW, THICK FILM	R-418-357
R399,R400,R488	RES, .0499, 1%, 100MW, THICK FILM	R-418-.0499
R401	RES, 301, 1%, 100MW, THICK FILM	R-418-301
R411,413,417,419,474,483	RES, 100, 1%, 100MW, THICK FILM	R-418-100
R421,R422,R480	RES, 200K, 1%, 125MW, METAL FILM	R-391-200K
R429,433,434,436,356,371	RES, 7.5, 5%, .5W, THICK FILM	R-469-7.5
R432	RES, 3.01K, 1%, 100MW, THICK FILM	R-418-3.01K
R455	RES, .1, 1%, 3W	R-475-.1
R462-464,467,468	RES, 10K, 1%, 100MW, THICK FILM	R-418-10K
R465,R494	RES, 11K, 1%, 100MW, THICK FILM	R-418-11K
R469	RES, 49.9K, 1%, 100MW, THICK FILM	R-418-49.9K
R470,R497	RES, .2, 1%, 30W	R-463-.2
R471	RES, .1, 1%, 30W	R-463-.1
R475,R484	RES, 47.5, 1%, 100MW, THICK FILM	R-418-47.5

Table 4-6 (continued)*Model 2303B analog board parts list*

Circuit designation	Description	Keithley part no.
R479	RES, 20K, .1%, .125W, THIN FILM	R-456-20K
R481,R482	RES, 4.99K, .1%, .125W, THIN FILM	R-456-4.99K
R493	RES, 45.3K, 1%, 100MW, THICK FILM	R-418-45.3K
R498	RES, .2, 1%, 1W (2512)	R-441-.2
R500,R501,R502,R507	RES, 18.5%, 1W 200V, THICK FILM	R-437-18
T301	TRANSFORMER	TR-314A
TP301-310,311,314,316-318	CONNECTOR	CS-985
U301,U321	DUAL FET OPAMP	IC-1128
U302,U304,U308,U316,U335	PRECISION BIFET OPAMP	IC-1194
U303	IC, QUAD 2 IN AND, 74HCT08	IC-837
U305,U307	IC, VOLTAGE REGULATOR, LM340-12	IC-60
U306,U311,U322,U330	IC, VOLT COMPARATOR LM393D	IC-775
U310	MICROPOWER VOLTAGE REGULATOR	IC-1152
U312	LOW POWER INSTRUMENT AMP	IC-1124
U313	IC, NEG VOLTAGE REG -15V, 500MA, 79M15	IC-195
U314	HIGH SPEED PWN CONTROLLER	IC-1120
U315	IC, +5V VOLTAGE REGULATOR, LM2940CT	IC-576
U317	DUAL \pm 15V ZERO DRIFT OPAMP	IC-1126
U320	IC, POS VOLTAGE REG +15V, 500MA, 78M15	IC-194
U324	IC, CMOS ANAL SWITCH, DG444DY,	IC-866
U327	80V 2.5A FULL BRIDGE FET DRIVER	IC-1139
U329	IC, VOLT. COMPARATOR, LM311M	IC-776
U333	POWER OUTPUT STAGE AUTOMATIC BIAS	IC-1159
U334,U336	IC, DUAL OP-AMP, LF353M	IC-842
VR303,VR310	DIODE, ZENER, 6.8V, MMSZ5235BT1	DZ-100
VR305,VR312	DIODE, ZENER, MM524694 TI	DZ-113
VR306,VR307	DIODE, ZENER, 6.0V, BZX84B6V2	DZ-87
VR311	DIODE, ZENER	DZ-121

Table 4-7
Model 2303B mechanical parts list

Qty.	Description	Keithley part no.
1	BEZEL, REAR	428-303D
1	COVER	2000-307C
1	FAN	FN-34-1
2	FOOT	428-319A
2	FOOT, EXTRUDED	FE-22A
2	FOOT, RUBBER	FE-6
1	FUSE, 2A, 250V, TIME LAG (5X20MM) F100	FU-81
1	HANDLE	428-329F
1	LINE CORD	CO-7
1	LINE FILTER	LF-11
1	MOUNTING EAR, LEFT	428-338B
1	MOUNTING EAR, RIGHT	428-328E
1	POWER ROD	704-313A

A Specifications

Specifications

The following pages contain the condensed specifications for the 2303. Every effort has been made to make these specifications complete by characterizing its performance under the variety of conditions often encountered in production, engineering, and research.

Absolute accuracy

All DC specifications are given as relative accuracies. To obtain absolute accuracies, the absolute uncertainties of the calibration sources must be added to the relative accuracies. The absolute uncertainties for the calibration sources used during Keithley's factory calibration are included in the specifications. The uncertainties of the operator's sources may be different.

All AC specifications are given as absolute accuracies.

Typical accuracies

Accuracy can be specified as typical or warranted. All specifications shown are warranted unless specifically noted. Almost 99% of the 2303's specifications are warranted specifications. In some cases it is not possible to obtain sources to maintain traceability on the performance of every unit in production on some measurements (e.g., high-voltage, high-frequency signal sources with sufficient accuracy do not exist). These values are listed as typical.

DC VOLTAGE OUTPUT (2 YEARS, 23°C ± 5°C)

OUTPUT VOLTAGE: 0 to +15VDC.

OUTPUT ACCURACY: ±(0.05% + 10mV).

PROGRAMMING RESOLUTION: 5mV.

READBACK ACCURACY¹: ±(0.05% + 3mV).

READBACK RESOLUTION: 1mV.

OUTPUT VOLTAGE SETTling TIME: 5ms to within stated accuracy.

LOAD REGULATION: 0.01% + 2mV.

LINE REGULATION: 0.5mV.

STABILITY²: 0.01% + 0.5mV.

TRANSIENT RESPONSE TO 1000% LOAD CHANGE:

Transient Recovery Time^{3,4}: <40µs to within 100mV of previous level.

<80µs to within 20mV of previous level.

Transient Voltage Drop: <100mV, typical.³

<200mV, typical.⁴

RIPPLE AND NOISE (20Hz to 20MHz): 3mV rms/8mV p-p, typical.

REMOTE SENSE: Automatic, 1V max. drop in each lead. Add 2mV to the voltage load regulation specification for each 1V change in the negative output lead due to load current change.

DC CURRENT (2 YEARS, 23°C ± 5°C)

OUTPUT CURRENT: 0–9V: 5A max. >9V–15V: 3A max. (not intended to be operated in parallel).

SOURCE COMPLIANCE ACCURACY: ±(0.16% + 5mA)⁵.

PROGRAMMED SOURCE COMPLIANCE RESOLUTION: 1.25mA.

READBACK ACCURACY¹: 5A range: ±(0.2% + 400µA).

5mA range: ±(0.2% + 1µA).

READBACK RESOLUTION: 5A range: 100µA.

5mA range: 0.1µA.

CURRENT SINK CAPACITY: 0–5V: 2A max. 5V–15V: Derate 0.1A per volt above 5V.

LOAD REGULATION: 0.01% + 1mA.

LINE REGULATION: 0.5mA.

STABILITY⁴: 0.01% + 50µA.

DIGITAL VOLTMETER INPUT (2 YEARS, 23°C ± 5°C)

INPUT VOLTAGE RANGE: 0 to +20VDC.

INPUT IMPEDANCE: 10¹⁰Ω typical.

MAXIMUM VOLTAGE (either input terminal) WITH RESPECT TO OUTPUT LOW: –3V, +22V.

READING ACCURACY¹: ±(0.05% + 3mV).

READING RESOLUTION: 1mV.

DC GENERAL

MEASUREMENT TIME CHOICES: 0.01 to 10 PLC⁷, in 0.01PLC steps.

AVERAGE READINGS: 1 to 10.

READING TIME^{1,8,9}: 31ms, typical.

PULSE CURRENT MEASUREMENT OPERATION

TRIGGER LEVEL: 5mA to 5A, in 5mA steps.

TRIGGER DELAY: 0 to 100ms, in 10 μ s steps.

INTERNAL TRIGGER DELAY: 25 μ s.

HIGH/LOW/AVERAGE MODE:

Measurement Aperture Settings: 33.3 μ s to 833ms, in 33.3 μ s steps.

Average Readings: 1 to 100.

BURST MODE:

Measurement Aperture: 33.3 μ s.

Conversion Rate: 3600/second, typical.

Number of Samples: 1 to 5000.

Transfer Samples Across IEEE Bus in Binary Mode: 4800 bytes/second, typical.

LONG INTEGRATION MODE: Measurement Time⁶: 850ms (840ms) to 60 seconds in 16.7ms (20ms) steps.

GENERAL

ISOLATION (low - earth): 22VDC max.

PROGRAMMING: IEEE-488.2 (SCPI).

USER-DEFINABLE POWER-UP STATES: 5.

REAR PANEL CONNECTOR: 8-position quick disconnect terminal block for output (4), sense (2), and DVM (2).

TEMPERATURE COEFFICIENT (outside 23°C \pm 5°C): Derate accuracy specification by (0.1 \times specification)/°C.

OPERATING TEMPERATURE:

0° to 50°C (Derate to 70%).

0° to 35°C (Full power).

STORAGE TEMPERATURE: -20° to 70°C.

HUMIDITY: <80% @ 35°C non-condensing.

POWER CONSUMPTION: 150VA max.

REMOTE DISPLAY/KEYPAD OPTION: Disables standard front panel.

DIMENSIONS: 89mm high \times 213mm wide \times 360mm deep (3½ in \times 8½ in \times 14⅞ in).

NET WEIGHT: 3.2kg (7.1 lbs).

SHIPPING WEIGHT: 5.4kg (12 lbs).

INPUT POWER: 100-120VAC/220-240VAC, 50 or 60Hz (auto detected at power-up).

WARRANTY: One year parts and labor on materials and workmanship.

EMC: Conforms with European Union Directive directive 89/336/EEC

EN 55011, EN 50082-1, EN 61000-3-2 and 61000-3-3, FCC part 15 class B.

SAFETY: Conforms with European Union Directive 73/23/EEC EN 61010-1,

UL 3111-1.

AC LINE LEAKAGE CURRENT: 450 μ A @ 110VAC, typ.; 600 μ A @ 220V, typ.

RELAY CONTROL JACK: 1-channel, sink 150mA max., 15V max. 5V output, 100mA max., also available on jack. Accepts 0.173 in Bantam-type plug (CS-1003-1).

ACCESSORIES SUPPLIED: User manual, service manual, output connector mating terminal (part no. CS-846).

ACCESSORIES AVAILABLE:

Model 2304-DISP: Remote Display/Keypad (4.6 in \times 2.7 in \times 1.5 in). Includes 2.7m (9 ft) cable and rack mount kit.

Model 2303B: 2303 with blank front panel (only AC power indicator LED).

¹ PLC = 1.00.

² Following 15 minute warm-up, the change in output over 8 hours under ambient temperature, constant load, and line operating conditions.

³ Remote sense, at output terminals, 1000% load change; typical.

⁴ Remote sense, with 4.5m (15 ft) of 16 gauge wire and 1 Ω resistance in each lead to simulate typical test environment, up to 1.5A load change.

⁵ Minimum current in constant current mode is 6mA.

⁶ 60Hz (50Hz).

⁷ PLC = Power Line Cycle. 1PLC = 16.7ms for 60Hz operation, 20ms for 50Hz operation.

⁸ Display off.

⁹ Speed includes measurement and binary data transfer out of GPIB.

Accuracy calculations

The information below discusses how to calculate output, readback, and digital voltmeter input accuracy.

Output and compliance accuracy

Output and compliance accuracy are calculated as follows:

$$\text{Accuracy} = \pm(\% \text{ of output} + \text{offset})$$

As an example of how to calculate the actual output limits, assume the Model 2303, 2303B, or 2303-PJ is sourcing 10V. Compute the output range from output voltage accuracy specifications as follows:

$$\begin{aligned}\text{Accuracy} &= \pm(\% \text{ of output} + \text{offset}) \\ &= \pm[(0.05\% \times 10\text{V}) + 10\text{mV}] \\ &= \pm(5\text{mV} + 10\text{mV}) \\ &= \pm 15\text{mV}\end{aligned}$$

Thus, the actual output voltage range is: $10\text{V} \pm 15\text{mV}$, or from 9.985V to 10.015V.

Current compliance calculations are performed in exactly the same manner using the pertinent specifications and compliance current settings.

Readback accuracy

Readback accuracy is calculated similarly, except of course that voltage or current readback specifications are used. As an example of how to calculate the actual current readback limits, assume the actual current being measured is 1.5A. Using the 5A range current readback specifications, the current readback reading range is:

$$\begin{aligned}\text{Accuracy} &= \pm(0.2\% \text{ of reading} + 400\mu\text{A offset}) \\ &= \pm[(0.2\% \times 1.5\text{A}) + 200\mu\text{A}] \\ &= \pm(3\text{mA} + 400\mu\text{A}) \\ &= \pm 3.4\text{mA}\end{aligned}$$

In this case, the actual current readback reading range is: $1.5\text{A} \pm 3.2\text{mA}$, or from 1.4968A to 1.5032A.

Digital voltmeter input accuracy

Accuracy of the digital voltmeter can be computed in exactly the same manner. Use the digital voltmeter input accuracy specifications and the applied voltage in your calculations. For example, assume that 5V is applied to the digital voltmeter input. Reading range is:

$$\begin{aligned}\text{Accuracy} &= \pm(\% \text{ of reading} + \text{offset}) \\ &= \pm[(0.05\% \times 5\text{V}) + 10\text{mV}] \\ &= \pm(2.5\text{mV} + 10\text{mV}) \\ &= \pm 12.5\text{mV}\end{aligned}$$

The reading range is $5\text{V} \pm 12.5\text{mV}$, or from 4.988V to 5.012V.



B
Calibration Reference

Introduction

This appendix contains detailed information on the various Model 2303, 2303B, and 2303-PJ remote calibration commands, calibration error messages, and methods to detect the end of each calibration step.

Section 2 of this manual covers detailed calibration procedures.

Command summary

Table B-1 summarizes calibration commands. These commands are covered in detail in the following paragraphs.

Table B-1
Remote calibration command summary

Command	Description
:CALibration	Calibration subsystem.
:PROTeCted	Cal commands protected by password.
:CODE '<code>'	Unlock cal; changes code if cal is already unlocked. (Default code: KI002303.)
:COUNT?	Query number of times 2303 has been calibrated.
:DATE <yyyy>,<mm>,<dd>	Program calibration year, month, day.
:DATE?	Query calibration year, month, day.
:INIT	Initiate calibration (must be sent before other cal steps).
:SAVE	Save calibration data to EEPROM.*
:LOCK	Lock out calibration. (Abort if calibration is incomplete.)
:STEP0 <nrf>	Output full-scale voltage (14V).
:STEP1 <nrf>	Calibrate output voltage setting using external DMM reading.
:STEP2 <nrf>	Calibrate voltage measuring using external DMM reading.
:STEP3	Perform DVM input full-scale (14V) cal.
:STEP4 <nrf>	Output current (1.9A) for 5A full-scale cal.
:STEP5 <nrf>	Calibrate output current limit using calculated current.
:STEP6 <nrf>	Calibrate 5A measurement range using calculated current.
:STEP7	Output 5mA (500mA, Model 2303-PJ) nominal current for 5mA (500mA) range full-scale cal.
:STEP8 <nrf>	Calibrate 5mA (500mA, Model 2303-PJ) measurement range using calculated current.

* Calibration data will not be saved if:

1. Calibration was not unlocked with :CODE command.
2. Invalid data exists. (For example, cal step failed or was aborted.)
3. Incomplete number of cal steps were performed.
4. Calibration was not performed in the proper sequence.

Miscellaneous commands

Miscellaneous commands are those commands that perform such functions as saving calibration constants, locking out calibration, and programming date parameters.

:CODE

(:CALibration:PROTeCted:CODE)

Purpose	To unlock calibration so that you can perform the calibration procedure.
Format	:cal:prot:code '<code>'
Parameter	Up to an 8-character ASCII string, including letters and numbers.
Description	The :CODE command sends the calibration code and enables calibration when performing these procedures via remote. The correct code must be sent to the unit before sending any other calibration command. The default remote code is KI002303.
Notes	<ul style="list-style-type: none"> • The :CODE command should be sent only once before performing calibration. Do not send :CODE before each calibration step. • To change the code, first send the present code, then send the new code. • The code parameter must be enclosed in single quotes.
Example	:CAL:PROT:CODE 'KI002303' Send default code of KI002303.

:COUNT?

(:CALibration:PROTeCted:COUNT?)

Purpose	To request the number of times the Model 2303 has been calibrated.
Format	:cal:prot:count?
Response	Number of times calibrated.
Description	The :COUNT? query may be used to determine the total number of times the Model 2303 has been calibrated. The calibration count will also be displayed during the front panel calibration procedure.
Example	:CAL:PROT:COUNT? Request calibration count.

:DATE

(:CALibration:PROTeCted:DATE)

Purpose	To program the calibration date.
Format	:cal:prot:date <yyyy>, <mm>, <dd>

Parameters	<yyyy> = 1998 to 2097 <mm> = 1 to 12 <dd> = 1 to 31
Query	:cal:prot:date?
Response	<yyyy> , <mm> , <dd>
Description	The :DATE command allows you to store the calibration date in instrument EEROM for future reference. You can read back the date from the instrument by using the :DATE? query. The calibration date will also be displayed during the front panel calibration procedure.
Note	The year, month, and day parameters must be delimited by commas.
Example	:CAL:PROT:DATE 1998,11,20 Send cal date (11/20/98).

:INIT

(:CALibration:PROTECTED:INIT)

Purpose	To initiate calibration.
Format	:cal:prot:init
Description	The :INIT command initiates the calibration process and must be sent before all other commands except :CODE.
Note	The :INIT command should be sent only once at the beginning of the calibration procedure. Do not send :INIT before each calibration step.
Example	:CAL:PROT:INIT Initiate calibration.

:SAVE

(:CALibration:PROTECTED:SAVE)

Purpose	To save calibration constants in EEROM after the calibration procedure.
Format	:cal:prot:save
Description	The :SAVE command stores internally calculated calibration constants derived during comprehensive in EEROM. EEROM is non-volatile memory, and calibration constants will be retained indefinitely once saved. :SAVE is sent after all other calibration steps.
Note	Calibration will be only temporary unless the :SAVE command is sent to permanently store calibration constants. Calibration data will not be saved if: <ol style="list-style-type: none"> 1. Calibration was not unlocked by sending the :CODE command 2. Invalid data exists (for example, cal step failed.) 3. An incomplete number cal steps were performed. 4. Calibration was performed out of sequence.

Example :CAL:PROT:SAVE Save calibration constants

:STEP

(:CALibration:PROTected:STEP<n>)

Purpose To perform various calibration steps.

Format :cal:prot:step<n>

Parameters See Table B-2.

Description The :CAL:PROT:STEP<n> command performs calibration at the various points listed in Table B-2. See *Section 2* for details on test equipment and connections.

Note Calibration steps must be performed in the order listed in Table B-2, or an error will occur.

Example :CAL:PROT:STEP0 14 Perform cal step 0 (full-scale output).

Table B-2
Calibration step summary

Command	Description
:CALibration	Calibration subsystem.
:PROTected	Cal commands protected by password.
:STEP0 <nrf>	Output full-scale voltage (14V).
:STEP1 <nrf>	Calibrate output voltage setting using external DMM reading.
:STEP2 <nrf>	Calibrate voltage measuring using external DMM reading.
:STEP3	Perform DVM input full-scale (14V) cal.
:STEP4 <nrf>	Output current (1.9A) for 5A full-scale cal.
:STEP5 <nrf>	Calibrate output current limit using calculated current.
:STEP6 <nrf>	Calibrate 5A measurement range using calculated current.
:STEP7	Output 5mA (500mA, Model 2303-PJ) nominal current.
:STEP8 <nrf>	Calibrate 5mA (500mA, Model 2303-PJ) measurement range using calculated current.

Detecting calibration errors

If an error occurs during any calibration step, the Model 2303 will generate an appropriate error message. Several methods to detect calibration errors are discussed below.

Reading the error queue

As with other Model 2303 errors, any calibration errors will be reported in the error queue. Use the `:SYST:ERR?` query to read the error queue.

Error summary

Table B-3 summarizes calibration errors.

Table B-3
Calibration errors

Error number	Error message
+400	Voltage zero cal prepare error
+401	Voltage zero cal output error
+402	Voltage zero cal measure error
+403	DVM zero cal error
+404	Volt full scale cal prepare error
+405	Volt full scale cal output error
+406	Volt full scale cal meas error
+407	DVM full scale cal meas error
+408	Open circuit cal error
+409	5A source cal prepare error
+410	5A source cal output error
+411	5A source cal measure error
+412	5mA source cal prepare error*
+413	5mA source cal measure error*

*500mA with Model 2303-PJ.

Status byte EAV (Error Available) bit

Whenever an error is available in the error queue, the EAV (Error Available) bit (bit 2) of the status byte will be set. Use the `*STB?` query to obtain the status byte, then test bit 2 to see if it is set. If the EAV bit is set, an error has occurred, and you can use the appropriate error query to read the error and at the same time clear the EAV bit in the status byte.

Generating an SRQ on error

To program the instrument to generate an IEEE-488 bus SRQ (Service Request) when an error occurs, send the following command: *SRE 4. This command will enable SRQ when the EAV bit is set. You can then read the status byte and error queue as outlined above to check for errors and to determine the exact nature of the error.

Detecting calibration step completion

When sending remote calibration commands, you must wait until the instrument completes the current operation before sending another command. You can use either *OPC or *OPC? to determine when each calibration step is completed.

Using the *OPC command

Using *OPC is the preferred method to detect the end of each calibration step. To use *OPC, do the following:

1. Enable operation complete by sending *ESE 1. This command sets the OPC (operation complete bit) in the standard event enable register, allowing operation complete status from the standard event status register to set the ESB (event summary bit) in the status byte when operation complete is detected.
2. Send the *OPC command immediately following each calibration command. For example:
`:CAL:PROT:STEP0 14;*OPC`
Note that you must include the semicolon (;) to separate the two commands, and that the *OPC command must appear on the same line as the command.
3. After sending a calibration command, repeatedly test the ESB (Event Summary) bit (bit 5) in the status byte until it is set. (Use *STB? to request the status byte.)
4. Once operation complete has been detected, clear OPC status using one of two methods: (1) use the *ESR? query, then read the response to clear the standard event status register, or (2) send the *CLS command to clear the status registers. Note that sending *CLS will also clear the error queue and operation complete status.

Using the *OPC? query

With the *OPC? (operation complete) query, the instrument will place an ASCII 1 in the output queue when it has completed each step. To determine when the OPC response is ready, do the following:

1. Repeatedly test the MAV (Message Available) bit (bit 4) in the status byte and wait until it is set. (You can request the status byte by using the *STB? query.)
2. When MAV is set, a message is available in the output queue, and you can read the output queue and test for an ASCII 1.
3. After reading the output queue, repeatedly test MAV again until it clears. At this point, the calibration step is completed.

Generating an SRQ on calibration complete

An IEEE-488 bus SRQ (service request) can be used to detect operation complete instead of repeatedly polling the Model 2303. To use this method, send both *ESE 1 and *SRE 32 to the instrument, then include the *OPC command at the end of each calibration command line, as covered above. Clear the SRQ by querying the ESR (using the *ESR? query) to clear OPC status, then request the status byte with the *STB? query to clear the SRQ.

Refer to your controller's documentation for information on detecting and servicing SRQs.

C Calibration Programs

Introduction

This appendix includes calibration programs written in BASIC to help you in calibrating the Models 2303/2303B or Model 2303-PJ. Refer to *Section 2* for more details on calibration procedures, equipment, and connections. *Appendix B* covers calibration commands in detail.

Computer hardware requirements

The following computer hardware is required to run the calibration programs:

- IBM PC compatible computer.
- Keithley KPC-488.2 or KPC-488.2AT, or CEC PC-488 IEEE-488 interface for the computer.
- Two shielded IEEE-488 bus cables (Keithley Model 7007)

Software requirements

To use the calibration program, you will need the following computer software:

- Microsoft QBasic (supplied with MS-DOS 5.0 or later).
- MS-DOS version 5.0 or later.
- HP-style Universal Language Driver, CEHP.EXE (supplied with Keithley and CEC interface cards listed above).

Calibration equipment

The following calibration equipment is required:

- Keithley Model 2001 Digital Multimeter
- 4 Ω , 0.1%, 100W resistor
- 3k Ω , 0.1%, 0.25W resistor (Models 2303 and 2303B only)
- 30 Ω , 0.1%, 10W resistor (Model 2303-PJ only)

See *Section 2* for detailed equipment specifications as well as details on test connections.

General program instructions

1. With the power off, connect the Model 2303 and the digital multimeter to the IEEE-488 interface of the computer. Be sure to use shielded IEEE-488 cables for bus connections.
2. Turn on the computer, the Model 2303, and the digital multimeter. Allow the Model 2303 and the multimeter to warm up for at least one hour before performing calibration.
3. Make sure the Model 2303 is set for a primary address of 16.
4. Make sure the digital multimeter primary address is set to 17.
5. Make sure that the computer bus driver software (CECHP.EXE) is properly initialized.
6. Enter the QBasic editor, and type in the program below. Be sure to use the actual characterized resistor values when entering the parameters.
7. Check thoroughly for errors, then save the program using a convenient filename.
8. Run the program, and follow the prompts on the screen to perform calibration. For test connections, refer to the following figures in Section 2:
 - Voltage connections: Figure 2-2.
 - 5A current connections: Figure 2-3.
 - 5mA current connections (Models 2303 and 2303B): Figure 2-4.
 - 500mA current connections (Model 2303-PJ): Figure 2-5.

Program C-1

Model 2303/2303B calibration program

```

' Model 2303/2303B calibration program using Keithley Model 2001 DMM.
' Rev. 1.1, 1/15/98
' 2303 primary address = 16. 2001 primary address = 17.
OPEN "IEEE" FOR OUTPUT AS #1           ' Open IEEE-488 output path.
OPEN "IEEE" FOR INPUT AS #2           ' Open IEEE-488 input path.
PRINT #1, "INTERM CRLF"                ' Set input terminator.
PRINT #1, "OUTTERM LF"                 ' Set output terminator.
PRINT #1, "REMOTE 16 17"              ' Put 2303, 2001 in remote.
PRINT #1, "OUTPUT 16;*CLS"            ' Initialize 2303.
PRINT #1, "OUTPUT 16;*ESE 1;*SRE 32"  ' Enable OPC and SRQ.
PRINT #1, "OUTPUT 17::SYST:PRES"      ' Initialize 2001.
PRINT #1, "OUTPUT 17::FORM:ELEM READ"  ' Reading only.
C$ = ":CAL:PROT:STEP"                  ' Partial command header.
FourOhm = 4                            ' Use characterized 4 ohm value.
ThreeK = 3000                           ' Use characterized 3 k ohm value.
CLS
PRINT "Model 2303/2303B Calibration Program"
PRINT #1, "OUTPUT 16::CAL:PROT:CODE 'KI002303'" 'Unlock calibration.
PRINT #1, "OUTPUT 16::CAL:PROT:INIT"      ' Initiate calibration.
GOSUB ErrCheck
GOSUB KeyCheck
FOR I = 0 TO 8                            ' Loop for all cal steps.
IF I = 0 OR I = 4 OR I = 7 THEN          ' Prompt for test connections.
    READ Msg$
    PRINT Msg$
    GOSUB KeyCheck
END IF
I$ = STR$(I): C1$ = C$ + RIGHT$(I$, LEN(I$) - 1)
SELECT CASE I                             ' Build command string.
CASE 0
    Cmd$ = C1$ + " 14"
CASE 1, 2, 5, 6, 8
    GOSUB ReadDMM
    Cmd$ = C1$ + " " + Reading$
CASE 3, 7
    Cmd$ = C1$
CASE 4
    Cmd$ = C1$ + " 1.9"
END SELECT
PRINT #1, "OUTPUT 16;"; Cmd$; ";*OPC"    ' Send command string to 2303.
GOSUB ErrCheck
GOSUB CalEnd
NEXT I
LINE INPUT "Enter calibration date (yyyy,mm,dd): "; D$
PRINT #1, "OUTPUT 16::CAL:PROT:DATE "; D$
PRINT #1, "OUTPUT 16::CAL:PROT:SAVE"     ' Save calibration constants.
PRINT #1, "OUTPUT 16::CAL:PROT:LOCK"     ' Lock out calibration.

```

```

GOSUB ErrCheck
PRINT "Calibration completed."
PRINT #1, "LOCAL 16 17"
CLOSE
END
'
KeyCheck:                                ' Check for key press routine.
WHILE INKEY$ <> "": WEND                   ' Flush keyboard buffer.
PRINT : PRINT "Press any key to continue (ESC to abort program)."
```

DO: I\$ = INKEY\$: LOOP WHILE I\$ = ""

```
IF I$ = CHR$(27) THEN GOTO EndProg        ' Abort if ESC is pressed.
RETURN
'
CalEnd:                                    ' Check for cal step completion.
DO: PRINT #1, "SRQ?"                      ' Request SRQ status.
      INPUT #2, S                          ' Input SRQ status byte.
LOOP UNTIL S                              ' Wait for operation complete.
PRINT #1, "OUTPUT 16;*ESR?"              ' Clear OPC.
PRINT #1, "ENTER 16"
INPUT #2, S
PRINT #1, "SPOLL 16"                     ' Clear SRQ.
INPUT #2, S
RETURN
'
ErrCheck:                                  ' Error check routine.
PRINT #1, "OUTPUT 16::SYST:ERR?"
PRINT #1, "ENTER 16"
INPUT #2, E, Err$
IF E <> 0 THEN PRINT Err$: GOTO EndProg
RETURN
'
ReadDMM:                                   ' Get reading from DMM.
SLEEP 5
PRINT #1, "OUTPUT 17::FETCH?"
PRINT #1, "ENTER 17"
INPUT #2, Reading$
IF I = 5 OR I = 6 THEN Reading$ = STR$(VAL(Reading$) / FourOhm)
IF I = 8 THEN Reading$ = STR$(VAL(Reading$) / ThreeK)
RETURN
'
EndProg:                                   ' Close files, end program.
BEEP: PRINT "Calibration aborted."
PRINT #1, "OUTPUT 16::CAL:PROT:LOCK"
PRINT #1, "LOCAL 16 17"
CLOSE
END
Messages:
DATA "Connect DMM volts input to SOURCE and DVM IN terminals."
DATA "Connect DMM volts input and 4 ohm resistor to SOURCE and SENSE."
DATA "Connect DMM volts input and 3 k ohm resistor to SOURCE and SENSE."
```

Program C-2

Model 2303-PJ calibration program

```

' Model 2303-PJ calibration program using Keithley Model 2001 DMM.
' Rev. 1.0, 1/15/98
' 2303-PJ primary address = 16. 2001 primary address = 17.
OPEN "IEEE" FOR OUTPUT AS #1          ' Open IEEE-488 output path.
OPEN "IEEE" FOR INPUT AS #2          ' Open IEEE-488 input path.
PRINT #1, "INTERM CRLF"              ' Set input terminator.
PRINT #1, "OUTTERM LF"               ' Set output terminator.
PRINT #1, "REMOTE 16 17"             ' Put 2303-PJ, 2001 in remote.
PRINT #1, "OUTPUT 16;*CLS"           ' Initialize 2303-PJ.
PRINT #1, "OUTPUT 16;*ESE 1;*SRE 32" ' Enable OPC and SRQ.
PRINT #1, "OUTPUT 17::SYST:PRES"     ' Initialize 2001.
PRINT #1, "OUTPUT 17::FORM:ELEM READ" ' Reading only.
C$ = ":CAL:PROT:STEP"                ' Partial command header.
FourOhm = 4                          ' Use characterized 4 ohm value.
ThirtyOhm = 30                       ' Use characterized 30 ohm value.
CLS
PRINT "Model 2303-PJ Calibration Program"
PRINT #1, "OUTPUT 16::CAL:PROT:CODE 'KI002303'" 'Unlock calibration.
PRINT #1, "OUTPUT 16::CAL:PROT:INIT"      ' Initiate calibration.
GOSUB ErrCheck
GOSUB KeyCheck
FOR I = 0 TO 8                          ' Loop for all cal steps.
IF I = 0 OR I = 4 OR I = 7 THEN        ' Prompt for test connections.
    READ Msg$
    PRINT Msg$
    GOSUB KeyCheck
END IF
I$ = STR$(I): C1$ = C$ + RIGHT$(I$, LEN(I$) - 1)
SELECT CASE I                          ' Build command string.
CASE 0
    Cmd$ = C1$ + " 14"
CASE 1, 2, 5, 6, 8
    GOSUB ReadDMM
    Cmd$ = C1$ + " " + Reading$
CASE 3, 7
    Cmd$ = C1$
CASE 4
    Cmd$ = C1$ + " 1.9"
END SELECT
PRINT #1, "OUTPUT 16::"; Cmd$; ";*OPC"  ' Send command string to 2303-PJ.
GOSUB ErrCheck
GOSUB CalEnd
NEXT I
LINE INPUT "Enter calibration date (yyyy,mm,dd): "; D$
PRINT #1, "OUTPUT 16::CAL:PROT:DATE "; D$
PRINT #1, "OUTPUT 16::CAL:PROT:SAVE"    ' Save calibration constants.
PRINT #1, "OUTPUT 16::CAL:PROT:LOCK"    ' Lock out calibration.

```

```
GOSUB ErrCheck
PRINT "Calibration completed."
PRINT #1, "LOCAL 16 17"
CLOSE
END
'
KeyCheck:                                ' Check for key press routine.
WHILE INKEY$ <> "": WEND                   ' Flush keyboard buffer.
PRINT : PRINT "Press any key to continue (ESC to abort program)."
```

DO: I\$ = INKEY\$: LOOP WHILE I\$ = ""

IF I\$ = CHR\$(27) THEN GOTO EndProg ' Abort if ESC is pressed.

RETURN

'

CalEnd: ' Check for cal step completion.

DO: PRINT #1, "SRQ?" ' Request SRQ status.

 INPUT #2, S ' Input SRQ status byte.

LOOP UNTIL S ' Wait for operation complete.

PRINT #1, "OUTPUT 16;*ESR?" ' Clear OPC.

PRINT #1, "ENTER 16"

INPUT #2, S

PRINT #1, "SPOLL 16" ' Clear SRQ.

INPUT #2, S

RETURN

'

ErrCheck: ' Error check routine.

PRINT #1, "OUTPUT 16::SYST:ERR?"

PRINT #1, "ENTER 16"

INPUT #2, E, Err\$

IF E <> 0 THEN PRINT Err\$: GOTO EndProg

RETURN

'

ReadDMM: ' Get reading from DMM.

SLEEP 5

PRINT #1, "OUTPUT 17::FETCH?"

PRINT #1, "ENTER 17"

INPUT #2, Reading\$

IF I = 5 OR I = 6 THEN Reading\$ = STR\$(VAL(Reading\$) / FourOhm)

IF I = 8 THEN Reading\$ = STR\$(VAL(Reading\$) / ThirtyOhm)

RETURN

'

EndProg: ' Close files, end program.

BEEP: PRINT "Calibration aborted."

PRINT #1, "OUTPUT 16::CAL:PROT:LOCK"

PRINT #1, "LOCAL 16 17"

CLOSE

END

Messages:

DATA "Connect DMM volts input to SOURCE and DVM IN terminals."

DATA "Connect DMM volts input and 4 ohm resistor to SOURCE and SENSE."

DATA "Connect DMM volts input and 30 ohm resistor to SOURCE and SENSE."



D Instrument Control

Introduction

This appendix contains basic information on controlling the Model 2303 and 2303-PJ from the front panel, or programming the Model 2303, 2303B, or 2303-PJ over the bus. Refer to the user's manual for more detailed information.

Front panel control

Setting output values

Use the following general procedure to set Model 2303 or 2303-PJ output values:

1. Using the DISPLAY key, make sure the unit is in the ACTUAL V AND I display mode.
2. Press SET. The LSD (least-significant digit) in the voltage display area will blink, indicating that the unit is in the output setting mode.
3. Use the edit (arrow) keys to adjust the voltage value, then press SET. The LSD for the current value will then blink.
4. Use the edit keys to adjust the current value, and press SET. The display will then return to the readback mode (no blinking digits).

Setting the display mode

Press the DISPLAY key, then use the up or down arrow key to select the display mode. Use the ACTUAL V AND I mode when testing current and voltage, and select the DVM INPUT mode when testing the DVM input.

Selecting the current range

To select the 5mA (500mA, Model 2303-PJ) or 5A current readback range:

1. Press the MENU key.
2. Use the up or down arrow key to select the CURRENT RANGE menu item, then press ENTER.
3. Use the edit keys to select the desired current range, then press ENTER.
4. Press the MENU key to back out of the menu structure.

Turning on the output

To turn on the output, simply press the OPERATE key. Press OPERATE again to turn the output off.

IEEE-488 bus control

Table D-1 summarizes commands necessary to control the Models 2303, 2303B, and 2303-PJ for tests in this manual.

Table D-1
Basic remote commands

Command	Description
:SOUR:VOLT <voltage>	Set output voltage (0-15).
:SOUR:CURRE:LIM <current>	Set current limit (0-5).
:SENS:FUNC "VOLT"	Voltage readback mode.
:SENS:FUNC "CURR"	Current readback mode.
:SENS:FUNC "DVM"	DVM measurements.
:SENS:CURRE:RANG MAX	5A current readback range.
:SENS:CURRE:RANG MIN	5mA current readback range.*
:OUTP ON	Turn on output.
:OUTP OFF	Turn off output.
:READ?	Trigger and request reading.

*500mA for the Model 2303-PJ.

Setting output values

Use the :SOUR:VOLT or :SOUR:CURRE:LIM commands to set the output voltage and current limit respectively. For example, the following commands set the output voltage to 10V and the current limit to 3A:

```
:SOUR:VOLT 10
:SOUR:CURRE:LIM 3
```

Setting the reading mode

Use :SENS:FUNC to program the reading mode. For example, select DVM input readings with the following command:

```
:SENS:FUNC "DVM"
```

Turning on the output

Use OUTP ON and OUTP OFF to turn the output on and off respectively.

Requesting readings

To trigger and request a reading, first send the :READ? query, then address the instrument to talk in the usual manner. The type of readings sent will depend on the selected reading mode.

Basic control program

Use the program below to send commands to the unit. To request a reading, type in “:READ?” at the command prompt, or type in “Q” to exit the program. See Appendix C for information on computer hardware and software requirements.

Program D-1

Basic control programming

```
' Program to send basic commands to 2303. Primary address =16.
OPEN "IEEE" FOR OUTPUT AS #1           ' Open IEEE-488 output path.
OPEN "IEEE" FOR INPUT AS #2           ' Open IEEE-488 input path.
PRINT #1, "INTERM CRLF"               ' Set input terminator.
PRINT #1, "OUTTERM LF"                ' Set output terminator.
PRINT #1, "REMOTE 16"                 ' Put 2303 in remote.
CLS
Start: PRINT "Command: ";              ' Print command prompt.
LINE INPUT Cmd$                       ' Input command string.
IF Cmd$ = "Q" THEN GOTO Quit           ' Check for Q to quit.
PRINT #1, "OUTPUT 16;"; Cmd$          ' Send command to unit.
IF Cmd$ = ":READ?" THEN               ' Check for :READ? query.
    PRINT #1, "ENTER 16"               ' Address to talk.
    LINE INPUT #2, Reading$           ' Input reading string.
    PRINT Reading$
END IF
GOTO Start
Quit: PRINT #1, "LOCAL 16"             ' Got to local.
CLOSE
END
```

Index

5A range readback accuracy 1-9

A

Accuracy calculations A-6
Analog board removal 3-4
Acquiring date and count by remote 2-22
Assembly drawings 3-3

B

Basic control program D-4

C

Calibration 2-1
Calibration considerations 2-2
Calibration cycle 2-3
Calibration equipment C-2
Calibration programs C-1
Calibration reference B-2
Case cover removal 3-3
Change the code by remote 2-21
Changing the code from the front panel 2-21
Changing the calibration code 2-21
Command summary B-2
Compliance current accuracy 1-7
Computer hardware requirements C-2
Current readback accuracy 1-9

D

Detecting calibration errors B-6
Detecting calibration step completion B-7
Digital board removal 3-4
Digital voltmeter input accuracy 1-13, A-6
Disassembly 3-1
Disassembly procedures 3-3

E

Environmental conditions 1-2, 2-2
Error summary B-6
Example limits calculation 1-4

F

Factory service 4-2
Front panel calibration 2-4
Front panel control D-2
Front panel disassembly 3-4

G

General program instructions C-3
Generating an SRQ on calibration complete B-8
Generating an SRQ on error B-7

H

Handling and cleaning 3-2
Handling PC boards 3-2

I

IEEE-bus control D-3
Instrument control D-1
Instrument programming 1-5
Instrument re-assembly 3-5
Introduction 1-2, 2-2, 3-2, 4-2, B-2, C-2, D-2

L

Line power 1-3, 2-2

M

Miscellaneous commands B-3
Models 2303 and 2303B 5mA range readback accuracy 1-10
Model 2303-PJ 500mA range readback accuracy 1-11
Models 2303 and 2303B remote calibration procedure 2-15
Model 2303-PJ remote calibration procedure 2-18
Models 2303 and 2303-PJ parts lists 4-3
Model 2303B parts lists 4-14

O

Ordering information 4-2
Output and compliance accuracy A-3
Output voltage accuracy 1-5

P

Parts lists and component layouts 4-2
Performance Verification 1-1
Performing the verification test procedures 1-5
Program C-1 Model 2303/2303B calibration program C-4
Program C-2 Model 2303-PJ calibration program C-6
Program D-1 Basic control programming D-4

R

- Readback accuracy A-6
- Reading the error queue B-6
- Recommended calibration equipment 2-3
- Recommended test equipment 1-3
- Remote calibration 2-10
- Remote calibration commands 2-10
- Remote calibration display 2-11
- Remote calibration procedure 2-11
- Removing mechanical components 3-5
- Replaceable parts 4-1
- Requesting readings D-4
- Resetting the calibration code 2-22
- Resistor connections 1-3, 2-3
- Resistor considerations 1-4, 2-4

S

- Selecting the current range D-2
- Setting output values D-3
- Setting the display mode D-2
- Setting the reading mode D-3
- Software requirements C-2
- Solder repairs 3-2
- Specifications A-2
- Status byte EAV (Error Available) bit B-6
- Static sensitive devices 3-2

T

- Temperature and relative humidity 2-2
- Test considerations 1-5
- Test summary 1-5
- Turning on the output D-2, D-4

U

- Using the *OPC command B-7
- Using the *OPC? query B-7

V

- Viewing calibration date and count 2-22
- Viewing date and count from the front panel 2-22
- Verification limits 1-4
- Verification test requirements 1-2
- Voltage readback accuracy 1-7

W

- Warm-up period 1-2, 2-2

Service Form

Model No. _____ Serial No. _____ Date _____

Name and Telephone No. _____

Company _____

List all control settings, describe problem and check boxes that apply to problem. _____

Intermittent Analog output follows display Particular range or function bad; specify _____

IEEE failure Obvious problem on power-up Batteries and fuses are OK

Front panel operational All ranges or functions are bad Checked all cables

Display or output (check one)

Drifts Unable to zero Unstable

Overload Will not read applied input

Calibration only Certificate of calibration required Data required

(attach any additional sheets as necessary)

Show a block diagram of your measurement including all instruments connected (whether power is turned on or not). Also, describe signal source.

Where is the measurement being performed? (factory, controlled laboratory, out-of-doors, etc.) _____

What power line voltage is used? _____ Ambient temperature? _____ °F

Relative humidity? _____ Other? _____

Any additional information. (If special modifications have been made by the user, please describe.)

Be sure to include your name and phone number on this service form.

KEITHLEY

Keithley Instruments, Inc.

28775 Aurora Road
Cleveland, Ohio 44139

Printed in the U.S.A.